

# **Veterinary Digital Radiography System**

## **Operator's Manual**



©2023 Shenzhen Mindray Animal Medical Technology Co., Ltd. All Rights Reserved.

For this Operator's Manual, the issue date is 2023-03.

**IMPORTANT!**

**The system is veterinary use only.**

## Intellectual Property Statement

Shenzhen Mindray Animal Medical Technology Co., Ltd. (hereinafter called Mindray Animal Medical) owns the intellectual property rights to this product and this manual. This manual may refer to information protected by copyright or patents and does not convey any license under the patent rights or copyright of Mindray Animal Medical, or of others.

Mindray Animal Medical intends to maintain the contents of this manual as confidential information. Disclosure of the information in this manual in any manner whatsoever without the written permission of Mindray Animal Medical is strictly forbidden.

Release, amendment, reproduction, distribution, rental, adaptation, translation or any other derivative work of this manual in any manner whatsoever without the written permission of Mindray Animal Medical is strictly forbidden.

**mindray**, is the trademark of SHENZHEN MINDRAY BIO-MEDICAL ELECTRONICS CO., LTD. in China and other countries. All other trademarks that appear in this manual are used only for informational or editorial purposes. They are the property of their respective owners.

## Responsibility on the Manufacturer Party

Contents of this manual are subject to change without prior notice.

All information contained in this manual is believed to be correct. Mindray Animal Medical shall not be liable for errors contained herein or for incidental or consequential damages in connection with the furnishing, performance, or use of this manual.

Mindray Animal Medical is responsible for the effects on safety, reliability and performance of this product, only if:

- all installation operations, expansions, changes, modifications and repairs of this product are conducted by Mindray Animal Medical authorized personnel;
- the electrical installation of the relevant room complies with the applicable national and local requirements; and
- the product is used in accordance with the instructions for use.

---

**NOTE:**

This equipment must be operated by skilled/trained clinical professionals.

---

---

**⚠ WARNING**

It is important for the hospital or organization that employs this equipment to carry out a reasonable service/maintenance plan. Neglect of this may result in machine breakdown or personal injury.

---

## Warranty

THIS WARRANTY IS EXCLUSIVE AND IS IN LIEU OF ALL OTHER WARRANTIES, EXPRESSED OR IMPLIED, INCLUDING WARRANTIES OF MERCHANTABILITY OR FITNESS FOR ANY PARTICULAR PURPOSE.

## Exemptions

Mindray Animal Medical's obligation or liability under this warranty does not include any transportation or other charges or liability for direct, indirect or consequential damages or delay resulting from the improper use or application of the product or the use of parts or accessories not approved by Mindray Animal Medical or repairs by people other than Mindray Animal Medical authorized personnel.

This warranty shall not extend to:

- Malfunction or damage caused by improper use or man-made failure.
- Malfunction or damage caused by unstable or out-of-range power input.
- Malfunction or damage caused by force majeure such as fire and earthquake.
- Malfunction or damage caused by improper operation or repair by unqualified or unauthorized service people.
- Malfunction of the instrument or part whose serial number is not legible enough.
- Others not caused by instrument or part itself.

## Important Information

- It is the customer's responsibility to maintain and manage the system after delivery.
- The warranty does not cover the following items, even during the warranty period:
  - Damage or loss due to misuse or abuse.
  - Damage or loss caused by Acts of God such as fires, earthquakes, floods, lightning, etc.
  - Damage or loss caused by failure to meet the specified conditions for this system, such as inadequate power supply, improper installation or environmental conditions.
  - Damage or loss due to use of the system outside the region where the system was originally sold.

- Damage or loss involving the system purchased from a source other than Mindray Animal Medical or its authorized agents.
- This system shall not be used by persons other than fully qualified and certified medical personnel.
- DO NOT make changes or modifications to the software or hardware of this system.
- In no event shall Mindray Animal Medical be liable for problems, damage, or loss caused by relocation, modification, or repair performed by personnel other than those designated by Mindray Animal Medical.
- The purpose of this system is to provide physicians with data for clinical diagnosis. The physician is responsible for the results of diagnostic procedures. Mindray Animal Medical shall not be liable for the results of diagnostic procedures.
- Important data must be backed up on external memory media.
- Mindray Animal Medical shall not be liable for loss of data stored in the memory of this system caused by operator error or accidents.
- This manual contains warnings regarding foreseeable potential dangers, but you shall also be continuously alert to dangers other than those indicated. Mindray Animal Medical shall not be liable for damage or loss resulting from negligence or ignorance of the precautions and operating instructions described in this operator’s manual.
- If a new manager takes over this system, be sure to hand over this operator’s manual to the new manager.

## About This Manual



This operator’s manual describes the operating procedures for this system and the compatible probes. To ensure safe and correct operation, carefully read and understand the manual before operating the system.



---

### **NOTE:**

- If you find that the contents of the multi-language manuals are NOT consistent with the system or the English manuals, refer ONLY to the corresponding English manuals.
  - The accompanying manuals may vary depending on the specific system you purchased. Please refer to the packing list.
- 

## Meaning of Signal Words

In this manual, the signal words  **DANGER**,  **WARNING**,  **CAUTION**, **NOTE** and **TIP** are used regarding safety and other important instructions. The signal words and their meanings are defined as follows. Please understand their meanings clearly before reading this manual.

Signal word	Meaning
 <b>DANGER</b>	Indicates an imminently hazardous situation that, if not avoided, will result in death or serious injury.
 <b>WARNING</b>	Indicates a potentially hazardous situation that, if not avoided, could result in death or serious injury.

Signal word	Meaning
 CAUTION	Indicates a potentially hazardous situation that, if not avoided, may result in minor or moderate injury.
NOTE	Indicates a potentially hazardous situation that, if not avoided, may result in property damage.
TIP	Important information that helps you to use the system more effectively.

## Software Interfaces in this Manual

Depending on the software version, preset settings and optional configuration, the actual interfaces may be different from those in this manual.

## Conventions

In this manual, the following conventions are used to describe the buttons on the control panel, items in the menus, buttons in the dialog boxes and some basic operations:

- <Buttons>: angular brackets indicate buttons, knobs and other controls on the control panel.
- [Items in menu or buttons in dialog box]: square brackets indicate items in menus or buttons in dialog boxes.
- Select [Items or Buttons]: click the item or button in dialog boxes by using the left mouse button.
- [Items in menu] > [Items in submenu]: select a submenu item following the path.

## Operator's Manuals

The content of the operator manual, such as screens, menus or descriptions, may be different from what you see in your system. The content varies depending on the software version, options and configuration of the system.

# Contents

---

<b>1 Important Information .....</b>	<b>1 - 1</b>
1.1 Safety Precautions .....	1 - 1
1.2 Radiation Protection .....	1 - 3
1.3 Parts that can be used within animal environment .....	1 - 4
<b>2 System Overview .....</b>	<b>2 - 1</b>
2.1 Safety Classification .....	2 - 1
2.2 Introduction of Each Unit .....	2 - 2
2.3 Operator Console Control Software Overview .....	2 - 5
2.3.1 System Status Icons .....	2 - 6
2.3.2 Registration Management Screen .....	2 - 7
2.3.3 Exposure Checking Screen .....	2 - 8
2.3.4 History Exam Screen .....	2 - 9
2.3.5 Image Print Management Screen .....	2 - 10
2.3.6 Report Management Screen .....	2 - 11
2.4 Basic Operations .....	2 - 11
2.4.1 Perform Exposure .....	2 - 11
2.4.2 Adjust the size of the X-ray field .....	2 - 14
2.4.3 Adjust the Exposure Parameters .....	2 - 15
2.5 Symbols and Warning Labels .....	2 - 16
<b>3 System Preparation .....</b>	<b>3 - 1</b>
3.1 Power ON .....	3 - 1
3.1.1 Check before Powering ON .....	3 - 1
3.1.2 Power the System ON .....	3 - 2
3.2 Shutting Down the System .....	3 - 3
3.3 Adjust the Stationary Floating Table .....	3 - 3
3.4 Connecting USB Devices .....	3 - 4
<b>4 Setup .....</b>	<b>4 - 1</b>
4.1 System Setup .....	4 - 1
4.1.1 Setting the System Language .....	4 - 1
4.1.2 Device Configuration .....	4 - 1
4.1.3 User Management .....	4 - 2
4.1.4 Option Configuration and Authorization .....	4 - 2
4.1.5 Detector Calibration .....	4 - 2
4.1.6 Exam Information Display Configuration .....	4 - 4
4.1.7 Parameter Manager .....	4 - 4
4.1.8 Statistics .....	4 - 4

---

4.1.9 DICOM Image Printing Configuration .....	4 - 4
4.1.10 Log and Configuration Maintenance .....	4 - 5
4.1.11 Prepay Installment .....	4 - 5
4.1.12 Exposure Configuration .....	4 - 6
4.1.13 Electronic Manual .....	4 - 7
4.1.14 Register Manage Settings .....	4 - 7
4.1.15 Lock Equipment .....	4 - 8
4.1.16 Report Configuration .....	4 - 8
4.2 System Date and Time Setup .....	4 - 10
4.3 Network Setup .....	4 - 10
4.4 Disk Space Configuration .....	4 - 10
4.5 DICOM Setup .....	4 - 11
4.5.1 DICOM Local Preset .....	4 - 11
4.5.2 DICOM Worklist Preset .....	4 - 11
4.5.3 DICOM Print Preset .....	4 - 12
4.5.4 DICOM Storage Preset .....	4 - 14
4.5.5 MPPS Preset .....	4 - 15
4.5.6 DICOM SC Preset .....	4 - 16
4.5.7 DICOM Q/R Preset .....	4 - 16
4.6 System Information .....	4 - 16
<b>5 Starting an Exam .....</b>	<b>5 - 1</b>
5.1 Registration Management .....	5 - 1
5.1.1 Local registration .....	5 - 1
5.1.2 Registration Information Management .....	5 - 3
5.1.3 Animal Information Query .....	5 - 3
5.2 Exposure Checking .....	5 - 3
<b>6 Image Browsing and Processing .....</b>	<b>6 - 1</b>
6.1 Image Display .....	6 - 1
6.2 Thumbnail .....	6 - 1
6.3 Image Operation .....	6 - 1
6.4 Annotation .....	6 - 4
6.4.1 Position Identification .....	6 - 4
6.4.2 Text Annotation .....	6 - 5
6.4.3 Arrow Annotation .....	6 - 6
6.5 Measurements .....	6 - 6
6.5.1 Basic Operations and Buttons .....	6 - 7
6.5.2 Measurement Menu .....	6 - 7
6.5.3 Measurement Caliper .....	6 - 8
6.5.4 Results Window .....	6 - 9
6.5.5 Routine Measurements .....	6 - 9
6.5.6 Application Measurements .....	6 - 11
6.6 Image Postprocessing .....	6 - 14
6.7 Image Stitching .....	6 - 19
6.7.1 Starting Stitching Management .....	6 - 19
6.8 Image Confirmation .....	6 - 22

---

<b>7 Animal Data Management .....</b>	<b>7 - 1</b>
7.1 Searching an Animal .....	7 - 1
7.2 Animal Data View and Management .....	7 - 2
7.3 Image Compare .....	7 - 2
7.4 Sending Animal data .....	7 - 3
7.5 u-Link (applicable for CE region only) .....	7 - 3
7.6 Recycle Bin .....	7 - 3
7.7 Image Print .....	7 - 4
7.7.1 Thumbnail Area Operations .....	7 - 4
7.7.2 Image Adjustment .....	7 - 4
7.7.3 Print Typesetting .....	7 - 5
7.7.4 Thumbnail Area Operation .....	7 - 6
7.7.5 Print .....	7 - 6
7.8 Animal Task Management .....	7 - 7
7.9 DICOM Task Management .....	7 - 7
<b>8 Report Management .....</b>	<b>8 - 1</b>
8.1 Select a Report .....	8 - 1
8.2 Edit a Report .....	8 - 1
8.2.1 Modifying Animal Information .....	8 - 1
8.2.2 Adding Images .....	8 - 1
8.2.3 Adding Diagnosis Description .....	8 - 2
8.2.4 Setting Positive/Negative .....	8 - 2
8.3 Save a Report .....	8 - 2
8.4 Preview a Report .....	8 - 3
8.5 Print a Report .....	8 - 3
8.6 Deleting a Report .....	8 - 3
8.7 Knowledge Base Management .....	8 - 3
8.7.1 Adding a Knowledge Base .....	8 - 4
8.7.2 Modifying Template .....	8 - 4
8.7.3 Saving Report contents to Template .....	8 - 4
8.7.4 Adjusting Contents .....	8 - 5
<b>9 System Maintenance .....</b>	<b>9 - 1</b>
9.1 Operator's Tasks .....	9 - 1
9.2 Service Tasks .....	9 - 2
<b>10 System Specifications .....</b>	<b>10 - 1</b>
10.1 Technical Specifications .....	10 - 1
10.2 Specifications of X-ray Assembly (E7239X) .....	10 - 3
10.2.1 General Data .....	10 - 3
10.2.2 Maximum and Minimum Ratings .....	10 - 4
10.2.3 Maximum Rating Charts (Absolute Maximum Rating Charts) .....	10 - 6
10.2.4 Emission and Filament Characteristics .....	10 - 8
10.2.5 Thermal Characteristics .....	10 - 9
10.2.6 Dimensional Outline .....	10 - 10
<b>11 EMC Guidance and Manufacturer's Declaration .....</b>	<b>11 - 1</b>



# 1 Important Information

---

## 1.1 Safety Precautions

Please observe the following precautions to ensure animal and operator's safety when using this system.

---

### DANGER

**Do not operate this system and probes in an atmosphere containing flammable gases or liquids such as anesthetic gases, hydrogen, and ethanol, because there is danger of explosion.**

---

---

### WARNING

- **Contraindication:** Pregnant animal should avoid the examination by this system as much as possible. If there is any justified reason for them to conduct the examination, take protective actions as much as possible.
- **Target users:** This X-ray system is only intended for use by radiography specialists who have been trained by Mindray Animal Medical or the agent and have read through the operator's manual.
- **Intended use environment:** The main application site is medical institutions.
- **The service personnel not trained and authorized by Mindray Animal Medical are prohibited from opening the enclosure or panel of the equipment; otherwise, short circuit or electric shock may occur.**
- **The service personnel not trained and authorized by Mindray Animal Medical are prohibited from replacing all fuses in this X-ray system; otherwise, short circuit or electric shock may occur.**
- **To ensure system safety, do not connect a portable multi-jack socket to the system.**
- **This X-ray system can only be connected to a power grid with protective grounding; otherwise, electric shock may occur.**
- **Do not use this X-ray system with a high-frequency electrosurgical unit (ESU), high-frequency treatment equipment, or defibrillator; otherwise, the animal may suffer electric shock.**
- **To ensure system safety, do not use other peripherals or accessories than those provided or designated by Mindray Animal Medical.**
- **Signal output and input can only be connected to specified devices.**
- **It is not allowed for the operator to have contact with other animals and the electronic parts (such as the input/output terminal of the signal) of other devices that are connected to the system. Otherwise, it may produce the electrical shock to the animal.**

- The system uses a leakage circuit breaker as the mains power breaker. Before maintaining or repairing the equipment, cut off the power supply of the entire system.
  - Do not install irrelevant software on this system; otherwise, it may cause the system's breakdown and data loss.
  - Do not uninstall the operating software and modify the operating system configuration.
  - Do not enable the sleep mode when entering the Windows operation screen.
- 

## CAUTION

- Check that this equipment operates properly before using the X-ray system.
  - Keep away from venous catheters, urethral catheters, and other catheters connected to the animal while using the X-ray system.
  - This operator's manual does not describe clinical inspection techniques. Operators must select the proper inspection technique based on their professional knowledge and clinical experience.
  - When using iodine-containing contrast medium, strictly observe the instructions of the product.
  - The image acquisition workstation monitor of the X-ray system can be used only during operation. Clinical image diagnosis must be completed by using a professional medical diagnostic display to guarantee imaging performance.
  - Periodically maintain the equipment during the service life. When the service life ends, stop using the equipment.
  - Turn off the input power switch before cleaning this equipment to avoid electric shock.
  - If you want to connect the power plug of this equipment and that of the external device connected to this equipment to a socket, ensure that the socket is a wall socket with protective grounding and meets the requirements of the rated power identification plate. Use of a multifunctional socket may affect grounding and make the leakage current exceed the safety limit. Be sure to use the power cable delivered with the X-ray system.
  - Do not connect and disconnect the system peripherals in the electrified state. This operation can only be performed by professional personnel.
  - Do not use a USB memory device (e.g., a USB flash drive, removable hard disk) which has unsafe data. Otherwise, system damage may result.
  - Radio waves can cause the system to work abnormally.
    - If this system is used near radio transmitting equipment, radio waves may interfere with the normal operation of the system. Do not use or take any devices transmitting RF signals (such as cellular phones, transceivers and radio controlled products) in the room placing the system.
    - If any equipment that may generate radio waves is near the system, immediately shut down the equipment to ensure normal operation of the system.
  - If the mains supply is unstable and may affect the proper operation of the system, it is recommended to use an uninterruptible power supply.
  - Adjust the size of the beam limiting device before pressing the Prep/ Expose button, to protect the animal from absorbing excessive X-ray radiation.
  - Data may be lost if the system is powered off or encounters abnormal power failure during image acquisition.
- 

## **NOTE:**

- Accessory equipment (analog or digital) connected to the ultrasound system must comply with the relevant IEC standards (e.g., IEC 62368-1 audio/video, information and communication

technology equipment safety standard and IEC 60601-1 medical equipment standard). Furthermore, all configurations must comply with the standard IEC 60601-1. It is the responsibility of the person, who connects additional equipment to the signal input or output ports and configures a medical system, to verify that the system complies with the requirements of IEC 60601-1. If you have any questions regarding these requirements, consult the Customer Service Department or sales representative.

- The X-ray system is not waterproof. Avoid water splash on the surface of the equipment or water ingress inside the equipment. In the case of water splash, consult the Customer Service Department or sales representative.
  - Do not turn off the system power supply when data is being printed, saved, and transmitted; otherwise, the operation cannot be completed properly and file information may be lost
  - Do not shut down the system forcibly; otherwise, the disk data may be corrupted or the system may malfunction.
  - You should properly back up the system to a secure external storage media, including system configuration, settings and animal data. Data stored to the system's hard drive may be lost due to system failure, improper operation or accident.
  - While the X-ray system is running, the operator should keep all the moving parts of the system and the animal within his/her field of view and pay consistent attention.
  - To avoid scald, do not touch the enclosure of the X-ray tube or beam limiting device during long-term inspection.
  - Keep the body parts of the animal away from the moving assemblies of the system to avoid animal injury resulting from system movement.
  - Keep venous catheters, urethral catheters, and other catheters connected to the animal away from moving devices.
  - Disinfect and clean the components (such as the animal table surface) in contact with the animal before using the X-ray system.
  - Check the system clock of the system periodically, to ensure the accurate examination time of the animal.
  - Antivirus and virus-killing software must be installed on the system before network connection to prevent virus attacks.
  - To dispose of the system or any part, contact the Customer Service Department or sales representative. The manufacturer is not responsible for any system content or accessories that have been discarded improperly.
  - Contact the manufacturer to provide the circuit diagram, component list, legends, and calibration rules if necessary.
- 

## 1.2 Radiation Protection

The radiation protection of this X-ray system complies with IEC 60601-1-3 (for medical electrical equipment).

This system is equipped with a high-performance protective device that provides effective X-ray radiation protection and causes no harm under normal usage. However, the system cannot provide full protection, nor does it force the operator to take sufficient measures to protect the operator or others from direct or secondary radiation due to negligence, ignorance, or accidents.

Exposure to X-ray radiation may be damaging to health, and some of the effects of X-ray radiation are cumulative and may extend over a period of months or years. The best safety rule for the X-ray operator is to avoid exposure to the primary beam at all times. An effective protective measure is the use of lead shielding. To minimize dangerous exposure, use such items as lead screens, lead impregnated gloves, aprons, thyroid collars, and so on.

Choose appropriate technical parameters for each program to reduce the exposure dose of X-ray to the lowest level, and reach the best effect of imaging for diagnose. Carefully check the digital display and confirm the selected technical parameters before exposure. Pay special attention to the position of the decimal point in the value of current time product.

---

**⚠ WARNING**

**Do not use this system to conduct repeated exposure on the same animal at a high frequency.**

---

---

**⚠ CAUTION**

- **During X-ray radiography, use lead impregnated clothes, boards, or other dedicated protective devices to protect the animal's sensitive parts (such as gonad), the operator, or the animal's helper.**
  - **During X-ray radiography, other personnel than the animal and its helper are prohibited from entering the X-ray beam area, or they should keep a distance of at least 3 m from the area.**
  - **The operator should use protective tools and wear protective clothes adapted to the workload if the operator has to work in the X-ray system area during X-ray radiography.**
- 

It is necessary to monitor the radiation quantity received by the X-ray system operator to identify insufficient or incorrect radiation protection measures and potential serious radiation exposure. Such monitoring provides valuable cross-check information to determine whether the adopted safety measures are proper. The most effective means to determine the properness of existing protective measures is to use instruments (such as a personal radiation measurement device) to detect the radiation dosage. Radiation measurement should be performed on all the body parts of the operator that are exposed to radiation. The measurement results cannot exceed the acceptable range.

When using the equipment, abide by the local regulations and restrictions on radiation protection. Before operating the system, the professional personnel should be familiar with the exposure dosage against Ionizing Radiation and for the Safety of Radiation Sources and have received training in the system operation.

## 1.3 Parts that can be used within animal environment

- X-ray tube support device and X-ray source assembly
- Wall stand and its detector assembly
- Stationary floating animal table and detector assembly
- High voltage generator
- Footswitch

# 2 System Overview

---

## 2.1 Safety Classification

Basis of Classification	Type
According to the type of protection against electric shock	Class I
According to the degree of protection against electric shock	Type B applied part
According to the degree of protection against harmful ingress of water	Enclosed type equipment that does not prevent ingress of liquids
According to the recommended disinfection and sterilization method	/
According to the degree of safety of application in the presence of a FLAMMABLE ANESTHETIC MIXTURE WITH AIR or WITH OXYGEN OR NITROUS OXIDE	EQUIPMENT not suitable for use in the presence of a FLAMMABLE ANESTHETIC MIXTURE WITH AIR or WITH OXYGEN OR NITROUS OXIDE
According to the operation mode	The equipment works in continuous operation
Whether the equipment has the application part that protects against defibrillation release effect	The equipment has no application part that protects against defibrillation discharge effect.
According to the installation and use	Permanently installed equipment

## 2.2 Introduction of Each Unit

Figure 2-1 System Structure

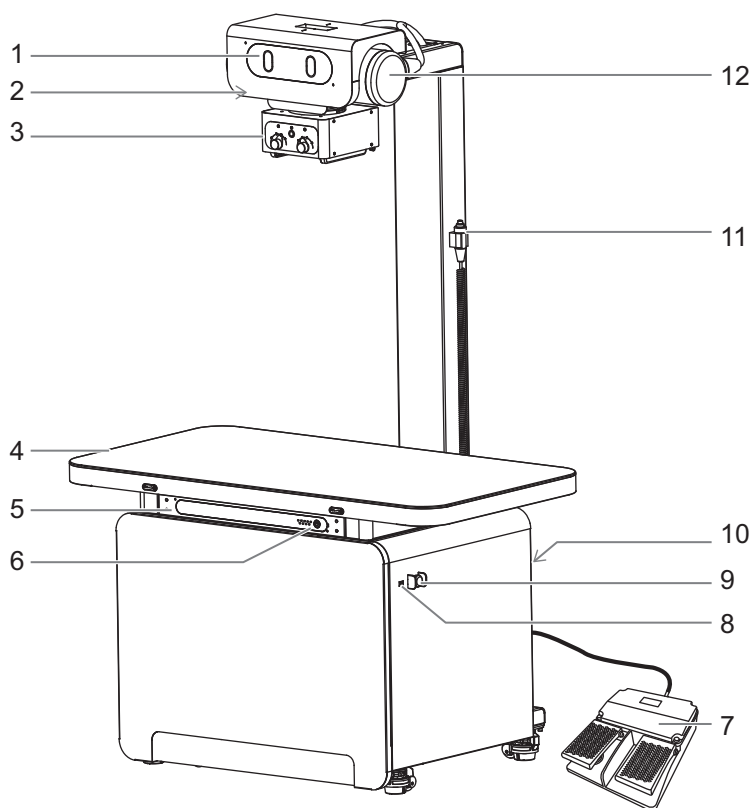

No.	Name	Description
1.	Exposure indicator	Indicates the exposure status.
2.	iVocal microphone	Built-in microphone for voice control.
3.	Beam limiting device	Used to adjust the size of the X-ray field.
4.	Stationary floating table	Used to place animals for radiographic examinations.
5.	Flat panel detector (FPD)	Used to receive X-rays.
6.	Power button/ Indicator panel	<ul style="list-style-type: none"> <li>Turn on/off the system.</li> <li>Indicates the operating status of the system.</li> </ul>
7.	Foot switch	<ul style="list-style-type: none"> <li>Left button: used to adjust the position floating table.</li> <li>Right button: used to control exposure.</li> </ul>
8.	USB port	Used to connect USB devices.

No.	Name	Description
9.	Emergency switch	<ul style="list-style-type: none"> <li>Press the emergency switch, the exposure stops, and the power indicator on the control box blinks continuously.</li> <li>When you turn the emergency switch, the button bounces instantly, the exposure and the machine motion function is restored. After the system is fully started, the power indicator on the control box stops blinking and keeps on.</li> </ul>
10.	Image acquisition workstation host computer	The workstation has the operator console control software installed to manage animal and image information.
11.	Exposure handswitch	Used to control the exposure of the system.
12.	Tube-collimator Assembly	Used to emit X-rays.

### Indicator Panel

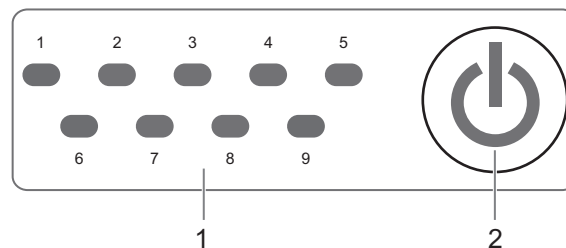

No.	Name	Description
1.	Component status indicators	Indicator 1: AC power supply indicator. Remains on after the AC power supply is connected.
		Indicator 2: Power-on/off status of the high voltage generator.
		Indicator 3: Indicator of the workstation.
		Indicator 4: Hard disk indicator of the workstation.
		Indicator 5: Reserved.
		Indicator 6: 12 V output power supply indicator.
		Indicator 7: 24 V output power supply indicator.
		Indicator 8: Sticky indicator of the left key of the footswitch
		Indicator 9: Emergency stop status indicator.
2.	Power on/off indicator	<ul style="list-style-type: none"> <li>Standby: Off</li> <li>Startup state: Steady on</li> <li>In the startup/shutdown process: Flashing</li> </ul>

## Host Computer Panel

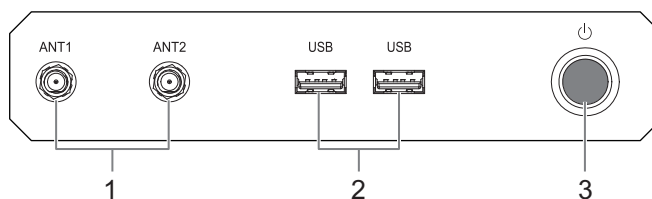

No.	Name	Description
1.	Antenna interfaces	Reserved.
2.	USB ports	Used to connect USB devices.
3.	Computer power button	Turn on/off the computer.  <b>NOTE:</b> For engineer use only.

## USB-Hub Parts

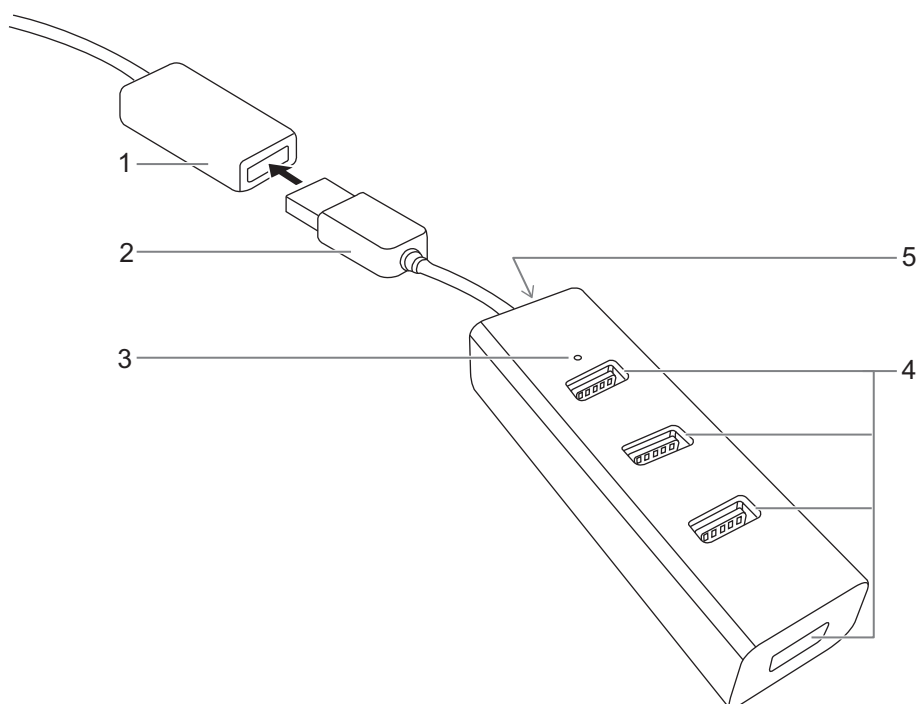

No.	Name	Description
1.	Host USB extension cable port	Used to connecting USB devices.
2.	USB plug	Used to connect to the host USB extension cable port.
3.	Indicator	Lights up when connected.



No.	Name	Description
4.	USB port (Type-A)	Used to connecting USB devices.  <b>NOTE:</b> It is only used to connect the keyboard and mouse. Do not connect other devices.
5.	USB port (Micro B)	Reserved.

## 2.3 Operator Console Control Software Overview

By default, the system enters the registration management screen after software login. The [RegManag] button is in selected state, as shown in Figure 2-2.

Operate with the keyboard and mouse:

- Click to select tabs, parameters, and set the parameter values.
- Use the keyboard to enter text information or parameter values.



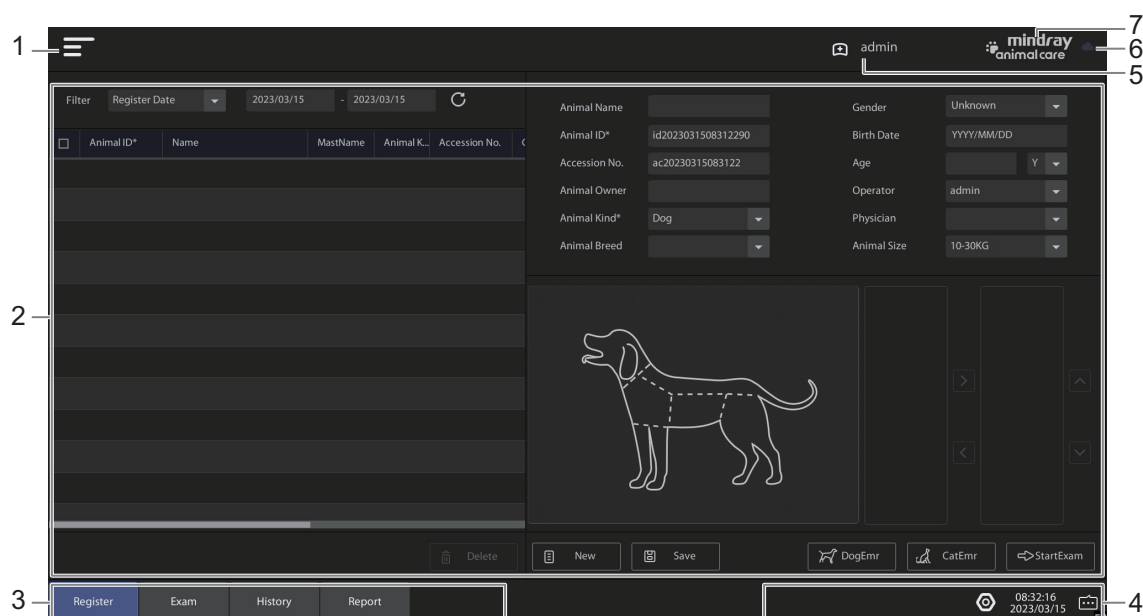





**Figure 2-2 Startup Initial Screen - Registration Management Screen**



No.	Name	Description
1.	Setup button	Enter/exit setup screen.
2.	Animal registration management area	Obtain the Worklist registered animals and local registered animals.
3.	Exam process icons area	Click to enter the corresponding function screen.
4.	System status icons area	Displays the system status icons.
5.	Login account	Displays the current login account.

No.	Name	Description
6.	u-Link	Enter the u-Link setup screen.
7.	System information button	View the system information.

### 2.3.1 System Status Icons

Icon	Description
	Indicates a high-voltage generator. Click to view details about the high-voltage generator.
	Indicates the connection status of the FPD. Click to view details about the FPD.
	Indicates storage space. Click to enter t disk space configuration screen.
	Indicates the network connection status. Click to view and set network connection.
	Click to enter DICOM settings, including local, Worklist, print, storage, etc.
	Indicates the task manager. Click to view the current system tasks.
	Indicates the DICOM task manager. Click to review the DICOM task status and redo the task.
	Click to hide/show the system icons.
	Click to view the operation information notification.
h:m:s YYYY/MM/DD	Displays the current system time.

## 2.3.2 Registration Management Screen

Figure 2-3 Registration management

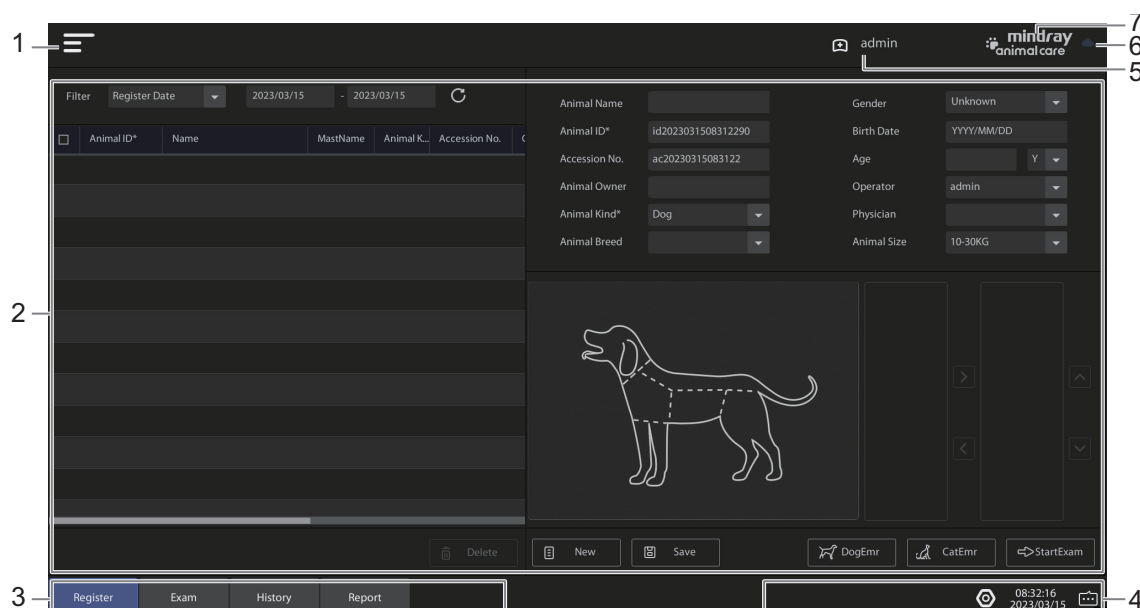

No.	Name	Description
1.	Registered animal list area	Displays the registered animals.
2.	Animal edit buttons	Add, delete, and modify animal registration information.
3.	Exam buttons	Enter the exam screen.  When a large number of animals need to be examined or treated, which requires quick input of animal information, you can use the emergency call registration function to register an animal
4.	Examined body part setting area	Select the body parts of the current animal to be radiographed from the examined body part list.
5.	Animal information registration area	Enter basic animal information.

## 2.3.3 Exposure Checking Screen

Figure 2-4 Exposure Checking

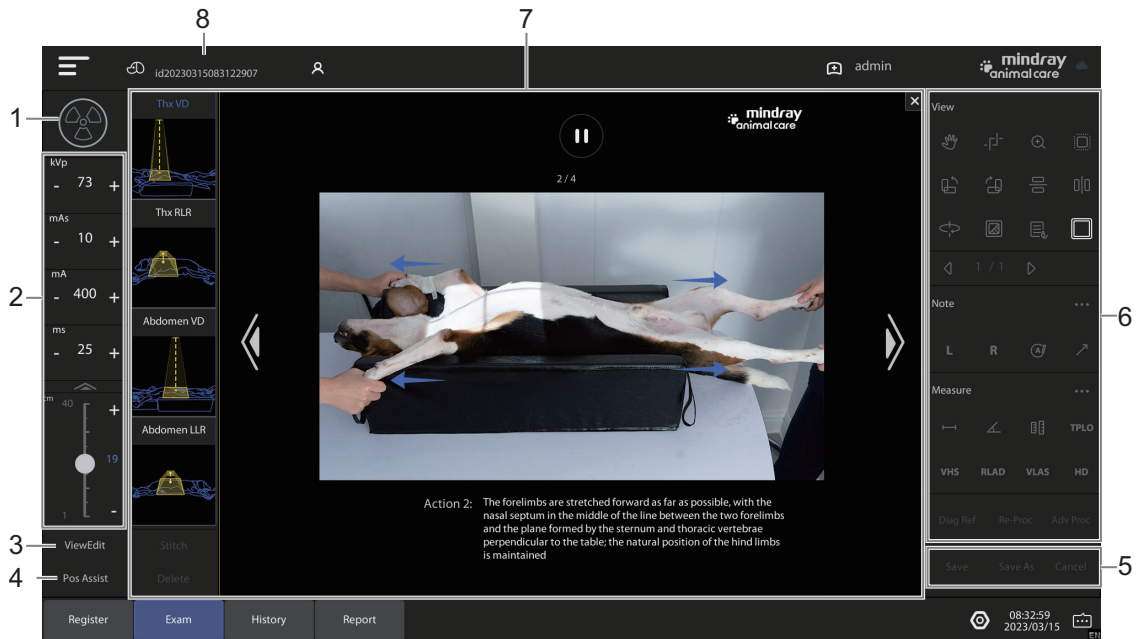

No.	Name	Description
1.	Exposure icon	Indicates the exposure status.
2.	Exposure parameter adjustment area	Displays the corresponding radiographed body part parameters. You can adjust the parameters based on the animal's conditions.
3.	Radiographed body part adjustment button	Edit the radiographed body parts to be exposed.
4.	Animal positioning prompt button	View the diagrams of the animal positioning.
5.	Image confirmation area	Image operation confirmation buttons.
6.	Image operation area	Adjust image, add comments, measure, etc.
7.	Image display area	<ul style="list-style-type: none"> <li>Displays the selected radiographed body parts and thumbnails.</li> <li>Displays the acquired images and exposure parameters.</li> </ul> <p>A proportional scale is displayed on each image to reflect the size proportion between the display image and the actual image. The scale marks are adjusted in real time as the image is zoomed in and out, to reflect proportional changes.</p> <ul style="list-style-type: none"> <li>View the diagrams of the animal positioning.</li> </ul>

No.	Name	Description
8.	Animal information area	Displays the current animal information.

## 2.3.4 History Exam Screen

Figure 2-5 History exam management

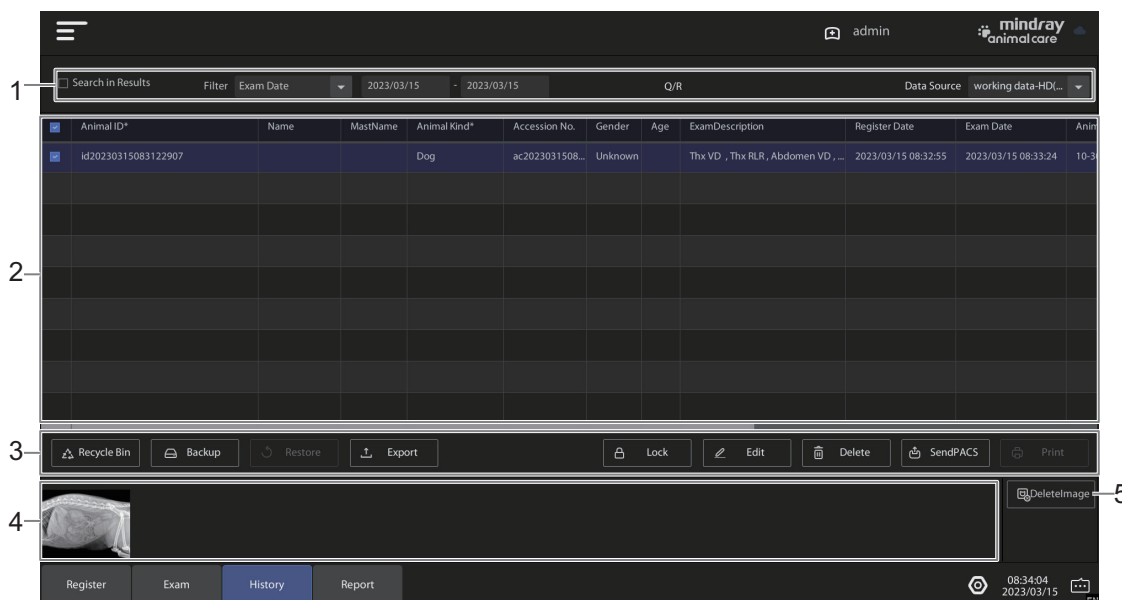

No.	Name	Description
1.	Animal information query area	Query and display animal information.
2.	Animal information list	Display the search results in the animal list based on the entered content.
3.	Animal information editing buttons	Edit the selected animal information.
4.	Thumbnail display area	Displays the thumbnail of the selected history animal exam.
5.	Image delete button	Delete the image of a selected animal record.

## 2.3.5 Image Print Management Screen

Figure 2-6 Image Print Management

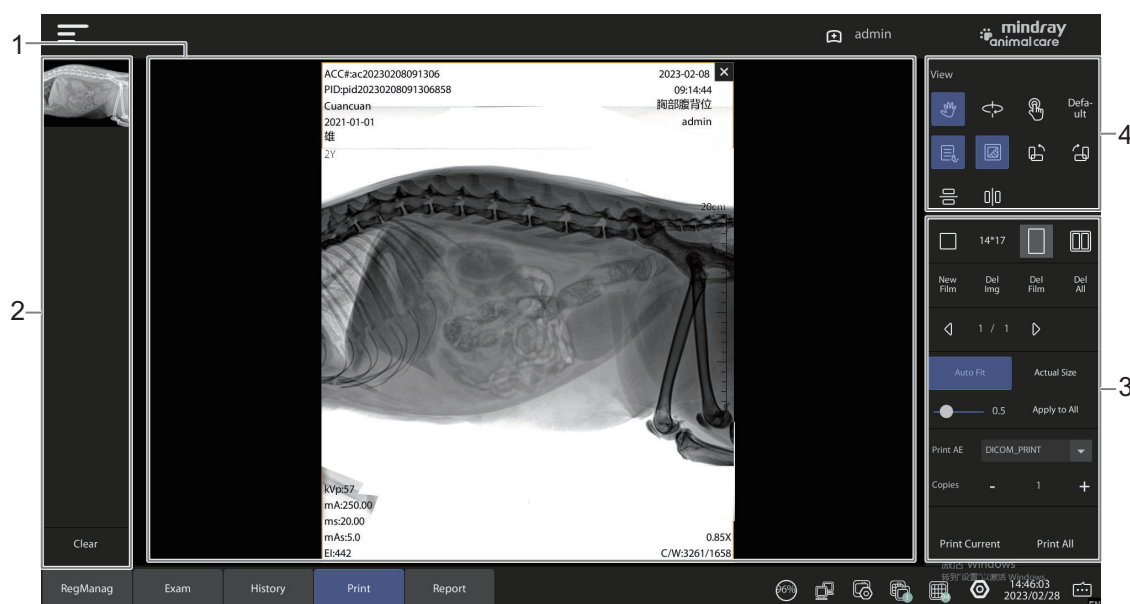

No.	Name	Description
1.	Printed image preview area	View the selected image.
2.	Thumbnail display area	Displays the thumbnails of the current exam. Click [Clear] to clear the image in the thumbnail display area.
3.	Print area	Set the print property and print operation.
4.	Image adjustment area	Adjust the selected image.

## 2.3.6 Report Management Screen

Figure 2-7 Report Management

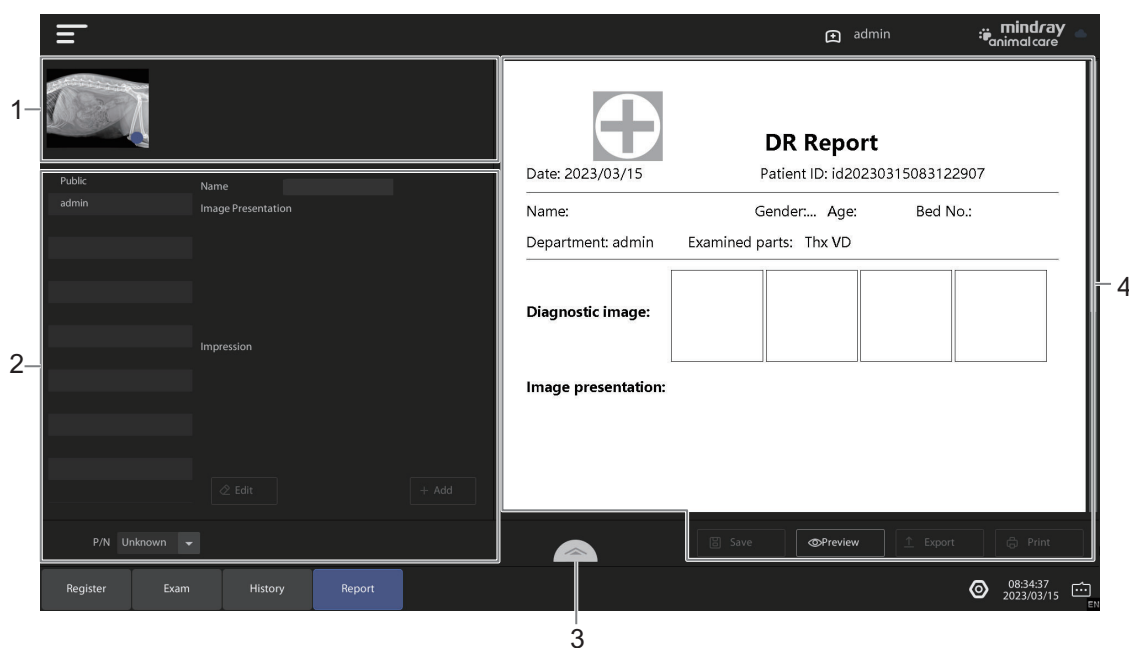

No.	Name	Description
1.	Thumbnail display area	Displays the thumbnails of the current exam.
2.	Library area	View the description of each symptom in the library.
3.	History report button	View the history report list. The selected report is displayed by default.
4.	Report editing area	Edit the selected report.



## 2.4 Basic Operations

### 2.4.1 Perform Exposure

#### Exposure Status Indication

The exposure indicator and the exposure icon on the exam screen display the exposure status.

Status	Indication	
	Exposure indicator	Exposure icon
Exposure is allowed	Lights in blue	 (Gray icon)

Status	Indication	
	Exposure indicator	Exposure icon
Prepare	Lights in green	 (Green icon)
Expose	Lights in yellow	 (Yellow icon, the peripheral circle is the image acquisition progress bar)

## Using the exposure handswitch

Figure 2-8 Exposure Handswitch

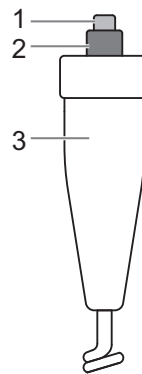

No.	Name	Description
1.	Prepare button	<ul style="list-style-type: none"> <li>Off: OFF position is when no pressure is applied to the button on the head of the handswitch.</li> </ul>
2.	Expose button	<ul style="list-style-type: none"> <li>Prepare: PREPARE is the middle position on the handswitch. When it is partially pressed, the system starts the X-ray tube and is ready to make an exposure. If the button is released, it returns to the OFF position</li> <li>Expose: When the button on the exposure handswitch is fully pressed, it is in the EXPOSE position.</li> </ul>
3.	Handle	For holding the hand switch.

Perform the following procedure:

1. Hold the handswitch.





2. Apply pressure to the button to start expose:

**NOTE:**

Exposure is stopped when the button on the head of the handswitch is released at any time during the exposure process.

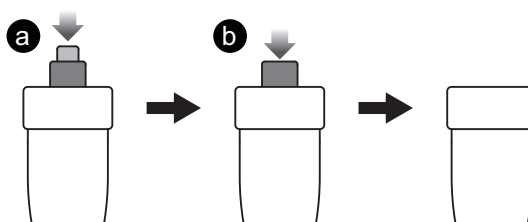

- a. Press the button to the middle position to enter the expose prepare status.
  - b. Press the button fully to start expose.
3. Release the Expose button after the exposure is completed.

### Using the foot switch

**Figure 2-9 Footswitch**

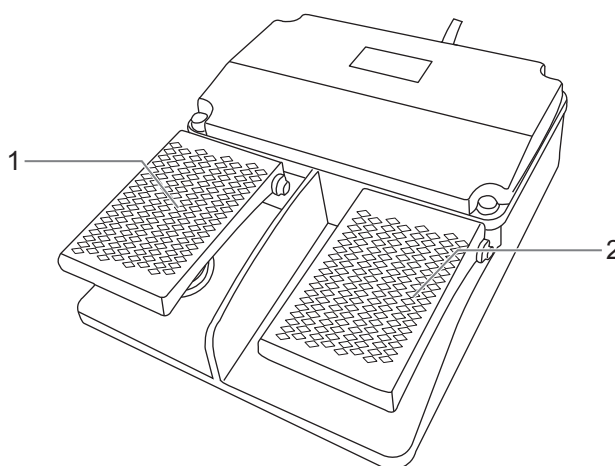

No.	Name	Description
1.	Left pedal	Used to adjust the position of the stationary floating table.
2.	Right pedal	Used to perform the exposure operation.

Do one of the following to start expose:

- Method 1:  
Press and hold the right pedal until exposure is complete and then release.
- Method 2:
  - a. Press and release the right pedal to enter exposure preparation status.
  - b. Press the right pedal again until the exposure is complete and then release.

### Using iVocal voice commands

You can use the iVocal voice command to control exposure.

Please operate within 0.5 m around the stationary floating table.

After the input command is recognized, the system automatically performs the corresponding operations.

The following table lists the supported voice commands by the factory:

Vocal command	Operation
Hi Ray, prepare	Turn on the voice control function and enter the exposure preparation status.
Hi Ray, expose	Start exposure.
Hi Ray, cancel	Exit the exposure status and the voice control function enters sleep status.

## 2.4.2 Adjust the size of the X-ray field

### Collimator

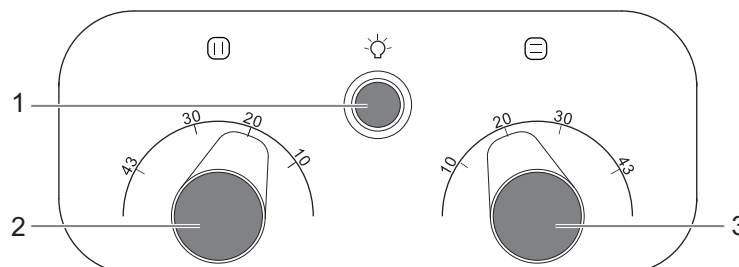

No.	Name	Description
1.	Light field button	Press to turn on the light source indicator of the light field device is on. It is off after a delay of 30 seconds (default)
2.	Lateral light field adjustment knob	Rotate clockwise to reduce the light field; rotate counterclockwise to enlarge the light field.
3.	Longitudinal light field adjustment knob	Rotate clockwise to enlarge the light field; rotate counterclockwise to reduce the light field.

### Adjusting the radiation field

Use the collimator to adjust the size of the X-ray field?

---

**NOTE:**

- Do not turn on the LED indicator of the beam limiting device repeatedly, and do not keep the indicator on for a long time, to avoid damaging the indicator due to overheat.
  - Do not turn on the LED indicator of the beam limiting device for a long time; otherwise, the enclosure area around the indicator may overheat and the indicator service life may be reduced.
  - Minimize the radiation area of the animal by adjusting the collimator only for a minimum area required for the purpose of diagnosis
- 

Perform the following procedure:

1. Press the light field button to turn on the light source indicator?  
It is off after a delay of 30 seconds (default). You can press the light field button to turn on the indicator as needed
2. Aim the light field at the animal's lesion, and adjust the light field size based on the selected field specifications by rotating the lateral/longitudinal light field adjustment knob.

### 2.4.3 Adjust the Exposure Parameters

---

**NOTE:**

- Adjust exposure parameters correctly based on the animal's body type.
  - Do not perform exposure until proper exposure parameters are selected for the animal.
- 

The system sets default parameters for each radiographed body part. You can adjust the default parameters based on the animal's conditions.

You can adjust the exposure parameters in the exposure parameter setup area of the Exam screen, as shown in Figure 2-10.

**Figure 2-10 Exposure Parameter Panel**

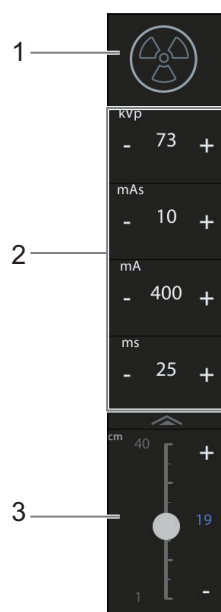

















No.	Name	Description
1.	Exposure icon	Indicates the current status of the exposure.
2.	Exposure parameters area	Adjust the following exposure parameters: kV (X-ray tube voltage), mA (X-ray tube current), ms (exposure time), mAs (exposure value). Click “+”/“-” to adjust the parameter value.
3.	Body thickness	Indicates the maximum distance between the front and rear surface of the body. Click “+”/“-” or drag the slider to adjust the thickness. Click  to expand the body thickness panel.











## 2.5 Symbols and Warning Labels

The symbols and warning labels of this system in order to call your attention to potential hazards.

Their meanings are explained as follows:

Symbol	Description
	Caution

Symbol	Description
	Refer to instruction manual/booklet
	Type-B applied part
	AC (Alternating current)
	Stand-by
	Protective earth (ground)
	Serial number
	Date of manufacture
	Manufacturer
	CE marking
	UKCA marking
	No sitting
	Emergency stop
	Foot switch exposure pedal
	Foot switch floating table top adjustment pedal
	Warning, electricity
	Warning; Hot surface

Symbol	Description
	Warning, radioactive material or ionizing
	Centre of gravity
	Plus; positive polarity
	Minus; negative polarity
	Temperature limit
	Humidity limitation
	Atmospheric pressure limitation
	MR Unsafe – the product is not intended to be used within magnetic resonance (MR) environment.
<b>Rx Only</b>	Caution: Federal Law restricts this device to sale by or on the order of a veterinarian.
	NRTL certification marking
	The following definition of the WEEE label applies to EU member states only: the use of this symbol indicates that waste electrical and electronic equipment must not be disposed of as unsorted municipal waste and must be collected separately. By ensuring that this product is disposed of correctly, you will help prevent bringing potential negative consequences to the environment and human health. For more detailed information with regard to returning and recycling this product, consult the distributor from whom you purchased the product.

---

Symbol	Description
	The maximum load bearing capacity of this device cannot exceed 80 kg

---

# 3 System Preparation

---

## 3.1 Power ON

---

### CAUTION

**To ensure safe and effective system operation, you must perform daily maintenance and checks. If the system begins to function improperly, immediately stop scanning. If the system continues to function improperly, fully shut down the system and contact the Customer Service Department or sales representative. If you use the system in a persistent improperly functioning state, you may harm the animal or damage the equipment.**

---

---

### *NOTE:*

Before system startup, make sure that the room is maintained in the operating environment specified by this document for 10 minutes.

---

### 3.1.1 Check before Powering ON

Check before the system is powered on:

- The temperature, relative humidity and atmospheric pressure meet the requirements of the operating conditions.
- There is no condensation.
- There is no distortion, damage or dirt on the system and peripheral devices.  
If any dirt is found, cleaning shall be performed, see the System Maintenance chapter.
- There are no loose screws on the monitor, control panel.
- There is no cable damage (e.g., power cord). Maintain secure connections to the system at all times.
- No miscellaneous odds and ends are attached or affixed to the control panel.
- Ensure that all connections are free from damage and remain clear of foreign object blockages.  
There are no obstacles around the system and its air vent.
- The entire scanning environment and field must be clean.



## 3.1.2 Power the System ON

After the power indicator is on, press the power button on the front panel. The following components are powered on or started:

- The image acquisition workstation starts up. The monitor displays the startup process. When the control software login screen of the operator console is displayed, the image acquisition workstation is started and ready.
- The high-voltage generator starts up. If the generator beeps for alarm, find the corresponding error code from the operator console control software and refer to the Maintenance Manual. No alarm indicates normal startup.
- After successful startup of the generator, other components of the system, such as the X-ray tube assembly, are started automatically.

### To log onto the system

The login screen is displayed after system startup.

To ensure security, the operator must perform identity authentication before accessing the control software system of the operator console.

1. Enter the correct user name and password on the login screen.



The password is case-sensitive. Specific characters of the password are not displayed during input.

The user name, password, and permissions are allocated by the system administrator.

2. Click  (Login) to enter the registration management screen of the operator console control software.

### To change users

Perform the following procedure:

1. Click  button.
2. Enter the user name and password.
3. Click  (Login) to enter the registration management screen of the operator console control software.

### To lock the system

Perform the following procedure:

1. Click  in the upper left corner of the screen to enter the system setup screen.
2. Select [Lock Machine] and the system is locked.

You must log on before using the system.

### To log out the system

Perform the following procedure:

1. Click  in the upper left corner of the screen to enter the system setup screen.

2. Select [Exit System] and the logout system screen is displayed:
  - [Shutdown]: shut down the computer.
  - [Logout]: close the operator console control software and enter the Windows operating system screen.
  - [Cancel]: return to the control software screen of the operator console.

## 3.2 Shutting Down the System

---

### WARNING

- **Data may be lost if the system is powered off or encounters abnormal power failure during image acquisition.**
  - **If the system cannot be powered off normally, press and hold the power button for more than 6 seconds to shut down the system forcibly.**
- 

### *NOTE:*

Do not shut down the system during image saving, sending or recording or online upgrade of board programs.

---

When the system is powered on, press the power button to power off the system. The X-ray tube assembly and other components of the system are switched off automatically.

In the power-on state, press the power button of the image acquisition workstation to exit the operator console control software. Then, the image acquisition workstation is shut down.

## 3.3 Adjust the Stationary Floating Table

The tabletop of the stationary floating table can be moved longitudinally or horizontally to meet different positioning requirements.

Perform the following procedure:

1. Step on the left pedal of footswitch to unlock the tabletop.

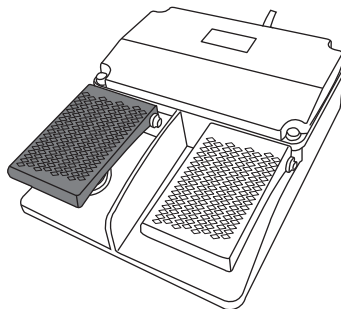

2. Press and hold the top of the tabletop and push/pull the tabletop to a proper position.

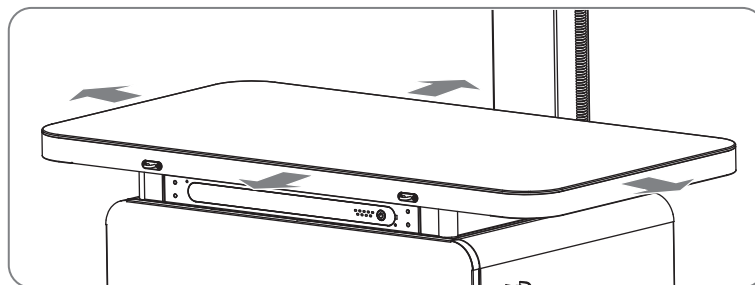

3. Release the pedal to lock the tabletop.

## 3.4 Connecting USB Devices

---

### WARNING

**DO NOT directly remove a USB memory device, as the USB device and/or the system may become damaged.**

---

When connecting a USB memory device to the system to the side USB port, and the USB symbol appears in the system status icon area of the screen if it is connected successfully.

To remove the USB device: click the USB symbol to open the [Remove USB Device] screen. Select the device to be removed and click [OK].

# 4 Setup

## 4.1 System Setup

Click  in the upper-left corner of the screen to enter the system configuration screen.

### 4.1.1 Setting the System Language

Perform the following procedure:

1. Select a language from the “Language” pull-down list.
2. Click [Apply], and restart the system as prompted.

### 4.1.2 Device Configuration

Select [Other Configurations].

Item	Description
Hospital Information	The hospital name to be displayed and printed.
Device information	<ul style="list-style-type: none"> <li>• Device type: Product model supported by the software.</li> <li>• Installation method: Forward installation and reverse installation.</li> </ul>
WorkMode	Select “Demo” to enable simulated exposure: the system performs simulated exposure (does not output the X-ray and generates a demo image) when the body part graph is double-clicked on the exam management screen.
Default input method	Set the default input method.
Workflow layout	Set the default workflow layout.  When the system is configured with UltraSync and QMate, the Show UltraSync button and the Show QMate button are optional.
Send Image	Set the default image destination.  Check whether to perform data masking when sending images to UltraSync.

### 4.1.3 User Management

Select [User Management]. On the user management page, you can add and delete users, change the user password, and assign permissions to common users.

---

**TIP:**

The following operations are limited to administrator users.

---

#### Adding a User

Click [Add] on the lower right corner of the screen, and the Add Users window is displayed. You can set the user name and password.

- The user name must contain numbers, letters, or Chinese characters.
- The password must contain numbers or letters.

#### Changing the Password

Select the desired user from the user list and click [Change Password] in the lower part of the screen. The following window is displayed. You can change the password. You can change the password.

#### Deleting a User

Select the user to be deleted from the user list and click [Delete] in the lower part of the screen. A confirmation box is displayed. Click OK to delete the user.

Click [OK] to delete the user, or click [Cancel] to cancel the deletion.

#### Assigning Permissions

You can select operation permissions for common users from the permission assignment list. After configuration, click [Save] to apply the settings.

### 4.1.4 Option Configuration and Authorization

Select [Option&Authorization].

This page displays the license status of the equipment and the license validity period of system functions or optional functions.

### 4.1.5 Detector Calibration

Select [Detector Cal.] to enter the FPD calibration screen. The screen displays calibration parameters in real time during FPD calibration, such as the current X-ray dosage and calibration progress.

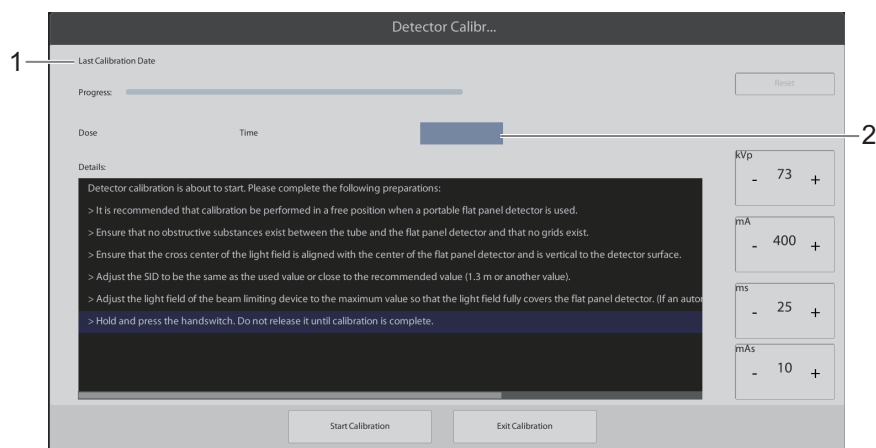

1.	Last calibration time
2.	Exposure prompt area

**NOTE:**

- Users need to calibrate the detector once a year to ensure the stability of the image quality received by the detector, so as to achieve the purpose of optimizing the image quality.
- Recalibrate the detector if the it has not been in use for more than 3 months.
- Ensure that the FPD has been powered on for more than 4 hours before FPD calibration.
- Only the administrator and authorized users have the right to calibrate the FPD.
- During the calibration, ensure that X-ray fully covers the FPD.
- Ensure that no foreign substances exist between point sources during calibration.

Perform the following procedure:

1. Manually maximize the light field of the collimator (completely covering the detector). Remove the obstacles between the light field and front baffle plate of the detector assembly.
2. After positioning is completed, click [Start Calibration] to calibrate the FPD and a prompt box will pop up.
3. Click [OK] to calibrate the FPD, and a prompt box pops up. After reading, click “All know, exit.”
4. When the exposure prompt area is in red and the prompt bar prompts for exposure, press the exposure hand switch for exposure.
5. Repeat the previous step until calibration is complete.

A pop-up window appears, and “Successful” is displayed in the Details area. Calibration is completed.

6. Select [OK] and then select [Exit Calibration].

## 4.1.6 Exam Information Display Configuration

Select [CheckInfoShowConfig].

Item	Description
FourCornerInfoSet	Set whether to print animal information entries and the print positions on films.
EntryAdjustSet	The list on the right displays the animal information that can be selected. The list on the right displays the content that will be displayed in the animal information list of the registration management screen.

## 4.1.7 Parameter Manager

This function is only available to service engineers. For more information, contact the Customer Service Department or sales representative.

## 4.1.8 Statistics

You can use the statistics function to view the workload under each account, and count the total number of persons and exposures based on time segments, examined parts, and other criteria.

You can export the statistical results as a CSV file through “Export Statistics”.

## 4.1.9 DICOM Image Printing Configuration

Item	Description
DicomPrintCnnfig	Display animal information on image: whether to display animal information on films.
Display the scale	Display proportional scale: whether to display a proportional scale on films.
Set Animal Information Print Front Size	Set the font size of animal information printed on film: the greater the value, the larger the font.
Close Thumbnail If print Success	After print is successful, the system automatically clears the thumbnails.
Print Layout Config	<p>Enable or disable the function of typesetting by body position.</p> <ul style="list-style-type: none"> <li>• Delete: Delete the configured body position selected. The default option cannot be deleted.</li> <li>• Modify: Modify the film size, print layout and film direction of the configured body position.</li> <li>• Add: Configure the film size, print layout and film direction of the new body position.</li> </ul>

Item	Description
AutoPrintImageConfig	<p>Automatic print image configuration when the network cable is plugged in:</p> <ul style="list-style-type: none"> <li>• Automatically print failed tasks: When this option is selected and the network cable is plugged in, the system automatically reprints the failed tasks.</li> <li>• Automatic print unprinted images: When this option is selected and the network cable is plugged in, the system automatically prints unprinted images within the set period. Automatic print time segment: The options are today, past three days, and past one week.</li> </ul>

## 4.1.10 Log and Configuration Maintenance

Item	Description	
LogAndMaintain	Delete Log?	Set whether to delete logs automatically.
	Log Keeping Days	Set the number of days during which logs are retained, if automatic log deletion is configured.
LogExport	Select Disk to Export	<p>Select destination for export. Click [Export]:</p> <p>Select the time period for export (today, past three days, past one month, customized, all), and click [Start] and wait. When the export is completed, the system prompts the corresponding information under “select the disk to export”.</p> <p>Click the [Remove Device] button, and select the USB flash disk to be removed on the removal screen for safe removal.</p>
BackAndRecovery	Add Backup	<p>Click to enter the backup dialog box, and enter the name of the system configuration to be backed up.</p> <p>After you click [OK], the added backup is displayed in the backup list.</p>
	Delete Backup	Click to delete the backup from the backup list.
	Restore Config	Click to restore system configuration from backup.
	Restore Default Config	Click to restore the default system configuration, which is not displayed in the backup list and cannot be deleted.

## 4.1.11 Prepay Installment

Display the prepay installment information. For detailed information, contact the Customer Service Department or sales representative.



## 4.1.12 Exposure Configuration

Item		Description
Exposure Control Set	ThickAdjust	Set the default body thickness range and body thickness step.
	AcqImageTime	Set the maximum exposure time of the FPD.
	AutoPostVideo	Set whether to auto play post assist video. When setting up auto play, you can set up the play interval.
	AfterExp Xs Auto switch to next body part	Set the time interval for automatically switching to the next position after exposure.
ImageProcessSet	SetBodyIcon Font Size	Set the font size of body part tag: A greater the value means a larger font size of the added body part tag during image browsing.
	Set Comment Font Size	Set the font size of comment: A greater the value means a larger font size of the note on the image browsing screen.
	Diagnostic Ref Image	Set the diagnostic reference graph library.
	Gray Window Factor	<ul style="list-style-type: none"> <li>Window width adjustment factor: A larger value means a higher speed for window width adjustment and a greater value change.</li> <li>Window level adjustment factor: A larger value means a higher speed for window level adjustment and a greater value change.</li> </ul>
	Modality Settings	Set the device type that is written when the DICOM file is saved.
	Preview Image After Exposure	If this option is selected, the unprocessed preview image is displayed after exposure.
	Display animal information on the image	Set whether the animal information is displayed by default.
	Enable Automatic BodyView Labeling	Set whether to automatically add body part tags based on body parts.
	Save Pure Image After Exposure	Set whether to save the Pure image when the animal is saved.
Save Raw Image After Exposure	Set whether to save the Raw image when the animal is saved.	

Item		Description
PlugInCable	Auto Send Failed Task	If this option is selected, the system will automatically send failed tasks after the data cable is connected.
	Auto Send UnSended	If this option is selected, the system will automatically send images not sent within the specified time period after the data cable is connected.  Automatic transmission time period: The options are today, past three days, and past one week.
CloseExamSet	Auto Send To PACS While Closing Exam	If this option is selected, the system sends the selected images to the PACS workstation when the animal on the image browsing screen is off.

### 4.1.13 Electronic Manual

View the detailed operating instructions.

### 4.1.14 Register Manage Settings

Item	Description
Default Animal Kind	Set the default animal type.
Animal Breed Set	Set the animal species.
Default Body Size Set	Set the weight range of the animal.
Emergency Body Set	Set the animal emergency body position.
Default Body Set	Set the default exam position of the animal.
Animal ID	Set whether the system automatically generates the default PID (Animal ID) during local login. Two generation modes are supported: <ul style="list-style-type: none"> <li>Manual: The system does not adopt the automatic generation rule. The PID is manually entered.</li> <li>Auto: The system automatically generates the PID. You can set the prefix of this PID (such as PID).</li> </ul>
Accession No.	Set whether the system automatically generates the default visit number during local login. Two generation modes are supported: <ul style="list-style-type: none"> <li>Manual: The system does not adopt the automatic generation rule. The accession No is manually entered.</li> <li>Auto: The system automatically generates the visit number. You can set the prefix of this visit number (such as AN).</li> </ul>

Item	Description
Age	Used to configure the method of worklist animal age calculation. <ul style="list-style-type: none"> <li>Calculate age based on the actual date: The age is calculated by subtracting the actual dates. If the subtraction result is less than one year, the actual month is used as the age. If the subtraction result is less than one month, the actual number of days is used as the age. If the subtraction result is more than one year, the actual year is used as the age.</li> <li>Calculate age based on year difference: The age is calculated by subtracting years.</li> </ul>
Operator	Sets operation doctor record rules.

### 4.1.15 Lock Equipment

You can use the device locking function to lock the system. To unlock the screen, log in again.

### 4.1.16 Report Configuration



Configure logo icon of the hospital, edit report template, select report printer, edit knowledge base and configure the report settings.

Item	Description
Hospital Logo	Provide the function of managing LOGO images of the hospital. <ul style="list-style-type: none"> <li>Clear: Clear the existing hospital logo image.</li> <li>Change: Change the image information of the hospital logo.</li> </ul>
Template	The default report template can be selected. <ul style="list-style-type: none"> <li>Click [Edit] to edit the report template.</li> <li>Click [Restore] to restore the templates to the original factory default.</li> </ul>
Printer	Set the default printer to print report.
Knowledge base	Provide the functions of knowledge base selection, import, export, and loading factory. <ul style="list-style-type: none"> <li>Click [Import] to import the local knowledge base.</li> <li>Click [Export] to export the knowledge base to the local device.</li> <li>Click [Restore] to restore the knowledge base to the factory default.</li> </ul>
Report Printing Settings	<ul style="list-style-type: none"> <li>Print after review: When this function is enabled, the report will be printed immediately after review.</li> <li>The report is reviewed and approved immediately after submission: After this function is enabled, the report will be reviewed and approved immediately after submission.</li> <li>Write a report immediately After the examination: After this function is enabled, enter the report module to write the report immediately after the exam is completed in the image browsing screen.</li> </ul>

## Adding a Report Template

Perform the following procedure:

1. Click [Edit] to edit the report template.
2. Click [New] to generate a blank template.

Item	Description
Add text	<p>Follow the steps below:</p> <ol style="list-style-type: none"> <li>1. Click  from the lower toolbar, press the left key and drag the mouse to add the size of text box.</li> <li>2. Double-click the text box to input text and click outside to end the editing.</li> </ol> <p>You can view and edit the control properties in the left column.</p>
Add the text with the print label	<p>Follow the steps below:</p> <ol style="list-style-type: none"> <li>1. Right-click the text and select print label.</li> <li>2. Select the text icon from the pop-up dialog box.</li> </ol> <p>Print label of the control is displayed in the left column.</p> <p>When you edit the text with print label in the report editor, the print label will be recognized and the corresponding animal data will be loaded into the text, but the animal data cannot be edited.</p>
Add text box	<p>The manual input of the report can be added to the edit box.</p> <p>Follow the steps below:</p> <ol style="list-style-type: none"> <li>1. Click  from the lower toolbar, press and hold the left mouse button to add and adjust the size and position of text box.</li> <li>2. Double-click the box to input text and click outside to end the editing.</li> </ol> <p>You can view and edit the control properties in the left column.</p> <ol style="list-style-type: none"> <li>3. Right click and select the print label.</li> <li>4. In the displayed print label dialog box, select the print label of the edit box.</li> </ol> <p>Print label of the control is displayed in the left column.</p> <p><b>NOTE:</b></p> <p>The print label must be added to the edit box, otherwise the edited content in the diagnosis report will not be saved.</p>
Alignment Control	<p>Follow the steps below:</p> <ol style="list-style-type: none"> <li>1. Hold down the Ctrl button, and then click to select the controls to be aligned.</li> <li>2. Select the alignment button at the bottom of the window.</li> </ol> <p>The specified alignment operation is performed.</p>

## Editing System Template

Perform the following procedure:

1. Click [Edit] to edit the report template.
2. Click [Open] and browse to select the template you want to edit.

Modify the template as needed. For details, see *Adding a Report Template* above.

## 4.2 System Date and Time Setup

---

### **NOTE:**

Ensure that the current exam date and time are the same as the system date and time.

---

Switch to Windows operating screen to set up the system date and time if necessary.

## 4.3 Network Setup

Click  to enter the Network Setup screen.

The network setup screen displays the network connection of the equipment and the IP address of the network adapter.

- Network card name: Displays all network card names in the system.
- Connection status: Displays the connection status of the currently selected network card.
- IP address: You can configure the system to automatically obtain an IP address, or set an IP address manually.

## 4.4 Disk Space Configuration

Click  (Disk space setup) to enter disk space setup screen.

Item	Description
Image Delete	<ul style="list-style-type: none"> <li>• Don't auto delete image: Delete the image manually as needed.</li> <li>• Auto delete image by time: When the maximum storage time is reached, the system will automatically delete the images that have been saved for a long time.</li> <li>• Auto delete image by capacity: When the remaining storage space reaches the set value, the system will automatically delete the images according to the storage order.</li> </ul> <p><b>NOTE:</b> The deleted images will be saved to the recycle bin. You can restore the deleted image from the recycle bin before the recycle bin is cleared.</p>
Recycle	<ul style="list-style-type: none"> <li>• Do not clean the recycle bin automatically: Clean the recycle bin manually as required.</li> <li>• Automatically clean up the recycle Bin: When the maximum storage days are reached, the device automatically deletes the animal data of the recycle bin that exceeds the storage days.</li> </ul> <p><b>NOTE:</b> The cleaned data in the recycle bin cannot be recovered. Back up animal data before enabling the auto clean recycle bin function.</p>

## 4.5 DICOM Setup

Click  (DICOM Setup) to enter the DICOM setup screen.

### 4.5.1 DICOM Local Preset

Select "Local" tab, you can configure the local DICOM entity name and port number

### 4.5.2 DICOM Worklist Preset

On this page, you can set DICOM Worklist parameters and test connection.

#### Worklist Configuration

Item	Description
Enable Worklist	If it is selected, the Worklist function will be enabled.
AE Title	Application Entity title. It is consistent with that of the Worklist server.
Port	DICOM communication port. The port should be consistent with that of the Worklist server port.
IP Address	IP address of the Worklist node. The value consists of four segments of integers ranging from 0 to 255.

Item	Description
Verification	Verify whether each worklist node is connected.

### Worklist Search Conditions

Item	Description
Time Range	Set the date range.
Refresh intervals	Set the worklist communication interval.
Identity	Set the identity of a task list.
Modality	Set the device type for obtaining information.
Age	Set the calculation method of age in the animal information obtained from worklist.

### Body View Map

Item	Description
Enable body part mapping	If it is selected, body part mapping is enabled.
Set the mapping label	Set the DICOM field for the worklist server to store body part information.
Worklist check tem:	Enter the information (such as the standard thorax position) sent by the worklist.
Adding a body part mapping	Follow the steps below: <ol style="list-style-type: none"> <li>1. In the worklist check item, enter the information sent by the worklist.</li> <li>2. In the body part list, select the body part corresponding to the DROC application.</li> <li>3. Click [Add] &gt; [Save] to add the body part mapping to the mapping list.</li> </ol>
Deleting a body part mapping	Select a body part in the body part list, and click [Delete] > [Save] to delete.

### 4.5.3 DICOM Print Preset

On this page, you can set DICOM Print parameters and test connection.

Item		Description
Printer Server List	Enable Print	If it is selected, the print service is enabled.
	Add	You can add and configure multiple print nodes. Follow the steps below: <ol style="list-style-type: none"> <li>1. Click [Add], and enter the following information about the added node in sequence: AE Title, port number, IP address and print brightness,</li> <li>2. Click [Save].</li> </ol> <p>The added node is displayed in the print node list. The attribute of the added node is displayed in the node attribute box.</p>
	Delete	You can delete the currently selected print node.
	Set Default	You can configure a default print node based on a default node.
	Cancel Default	You can cancel the currently selected default print node.
	Verification	Verify the connectivity of each DICOM print node.
Note Attribute	AE Title	Name of a DICOM node entity
	Port	Port number of the service provided by the DICOM node.
	IP Address	IP address of the DICOM node. The value consists of four segments of integers ranging from 0 to 255.
	Print Brightness	You can select the print effect after brightness compensation adjustment.



Item	Description	
Print Configuration	Min density	Enter the minimum density of the film.
	Max density	Enter the maximum density of the film.
	Border density	Set the density between film images.
	Empty Density	Set the density of the surrounding area.
	Film destination	Specify where the file is exposed.
	Medium Type	Specify print medium.
	Inter Type	Select how the printer magnifies an image to fit the film.
	Print Border	Set whether to print image border.
	Polarity	Set the default image polarity.
	Priority	Specify print job priority.
	Configuration	Enter configuration information in the field.
	Owner Tag	Displayed on the control software screen of the operator console. The value can be modified based on the requirements of the hospital
	Film Tag	You can change the value based on the requirements of the hospital. You can enter letters and numbers.
Set Film Size	sets the default film size. Click [Set Film Size] to select a film size.	

#### 4.5.4 DICOM Storage Preset

On this page, you can set DICOM Storage parameters and test connection.

Item		Description
Storage Server List	Enable Storage	If it is selected, the storage service is enabled.
	Add	You can add and configure multiple storage nodes.  Follow the steps below:  <ol style="list-style-type: none"> <li>1. Click [Add], and enter the following information about the added node in sequence: AE Title, port number, and IP address.</li> <li>2. Click [Save].</li> </ol> <p>The added node is displayed in the storage node list. The attribute of the added node is displayed in the node attribute box.</p>
	Delete	Click to delete the selected node in the storage node list.
	Set Default	You can configure a default storage node based on a default node.
	Cancel Default	You can cancel the currently selected default storage node.
	Verification	Verify the connectivity of each DICOM storage node.
Node Attribute	AE Title	Name of a DICOM node entity.
	Port	Port number of the service provided by the DICOM node.
	IP Address	IP address of the DICOM node. The value consists of four segments of integers ranging from 0 to 255.
	Enable Lossless Compression	If it is selected, the lossless compression is enabled.

### 4.5.5 MPPS Preset

On this page, you can set DICOM MPPS parameters and test connection.

Item	Description
Enable MPPS	If it is selected, the MPPS service is enabled.
AE Title	Name of a DICOM node entity.
IP Address	IP address of the DICOM node. The value consists of four segments of integers ranging from 0 to 255.
Port	Port number of the service provided by the DICOM node.
Verification	Verify the connectivity of the node.

## 4.5.6 DICOM SC Preset

On this page, you can set DICOM SC parameters and test connection.

Item	Description
Enable Storage Commit	If it is selected, the Storage Commit service is enabled.
AE Title	Name of a DICOM node entity.
IP Address	IP address of the DICOM node. The value consists of four segments of integers ranging from 0 to 255.
Port	Port number of the service provided by the DICOM node.
Verification	Verify the connectivity of the node.

## 4.5.7 DICOM Q/R Preset

On this page, you can set DICOM Q/R parameters and test connection.

Item	Description
Enable Q/R	If it is selected, the Query/Retrieve service is enabled.
AE Title	Name of a DICOM node entity.
IP Address	IP address of the DICOM node. The value consists of four segments of integers ranging from 0 to 255.
Modality	Set the device type, DX and DR are optional.
Port	Port number of the service provided by the DICOM node.
Verification	Verify the connectivity of the node.

## 4.6 System Information

Click the System information button on the upper right corner of the control software.

The Version windows is displayed, and the information includes the DROC, FPD, the high voltage generator, and the collimator.

# 5 Starting an Exam

---

## 5.1 Registration Management

You can start an animal exam in the following situations:

- Local registration
  - New animal information: to start a new animal exam, animal information must first be entered.
  - Return visit registration: to start a new exam for animal who is already registered, the recorded information can be obtained through history exams.
  - Emergency: Animal ID information is generated quickly.
  - Barcode scanning: to log data as animal ID by using the barcode reader.
- Worklist registration: register animals in the worklist.

### 5.1.1 Local registration

After startup, the system automatically enters the registration management screen. When the system is in another interface, click [Registration Management] to return to the registration management screen.

#### Manual Registration

Perform the following procedure:

1. Enter the animal information in the animal information registration area.
2. Select the body parts of the current animal to be radiographed from the examined body part list.
  - a. Select an exam part: Click the exam part area on the animal diagram, and load the body part library under the corresponding exam part.
  - b. Select body part: Click to select a body part in the body part library, and then click [➤] to add it to the body part list on the right side.  
Click [◀] to delete the selected body part from the selected body part list.  
In the selected body part list, use [^]/[v] to adjust the position order.
3. Click [Save] to register a new animal.

The completed registration animal information is displayed in the animal information list.

## Emergency Registration

When a large number of animals need to be examined or treated, which requires quick input of animal information, you can use the emergency call registration function to register an animal. Click the [DogEmr] or [CatEmr] button to enter exam, the system automatically generates an animal ID and directly enters the exam screen.

---

### **NOTE:**

After emergency call examination is completed, the animal information can be modified on the history screen.

---

## Return Visit Registration

On the history screen, double-click an animal information in the animal list to enter the exam screen.

click [Additional Exam] or [New Exam] to perform the return visit registration.

- Additional exam: Continue to use the previous animal registration information.
- New exam: Register a new animal based on the existing animal information.

## Barcode Scanning

---

### **NOTE:**

For how to configure the barcode scanner, see the manual supplied with the barcode scanner.

---

you can use the barcode scanner to search for animals in the following two modes.

- Click the animal list.  
Use the barcode scanner to scan an animal barcode. When a beep sound is generated to indicate successful scanning, the system identifies the animal corresponding to the barcode and loads the animal to the examination management screen.  
If the registration list contains at least two examinations of the animal, the system does not automatically jump to the exam screen. However, you can query all the exams of the animal in the list.
- In the upper part of the registration management screen, select Filter Criteria. Click the search box and use the barcode scanner to scan the animal barcode. When a beep sound is generated to indicate successful scanning, the animal barcode is displayed in the search box. The system successfully searches for all the exams of the animal corresponding to the barcode.

## Worklist Registration

Select  to download Worklist animal information.

The system automatically refreshes to obtain the worklist animal information.

---

### **TIP:**

For details about automatic refresh configuration, see *DICOM Worklist Preset* section in *Setup* chapter.

---

## 5.1.2 Registration Information Management

You can manage registered animal information, including viewing, modifying, and deleting animal information.

### Viewing Animal Information

In the animal information list, click to select the registered animal for examination, and view the selected animal information in the animal information registration area.

### Modifying Animal Information

---

***TIP:***

The animal information after radiography can be modified on the history screen.

---

You can modify the information about animals before radiography (examination).

Perform the following procedure:

1. In the animal information list, select the animal record to be modified and the animal information displays in the animal information registration area.
2. Modify the animal information as required in the animal information registration area.
3. Click [Save] to save the changes.

### Deleting Animal Information

In the animal information list, select a record and click [Delete] to delete the animal record.

## 5.1.3 Animal Information Query

You can query animal records based on filter criteria.

The query process automatically starts after search criteria are entered.

- When the criteria is set to “All”, the search bar is displayed on the right. Fuzzy search is supported. Input query conditions in the text box. The content can contain “\*” or be blank for fuzzy query.
- When the condition is set to “Register Date”, the time range is displayed, and the date range is selected by the pop-up box.

## 5.2 Exposure Checking

Perform the following procedure:

1. Register the animal information, and then click [Start Exam] to enter the exam screen.
2. Selecting a radiographed body part.

The radiographed body parts selected during registration are displayed in the thumbnail area.

Click the radiographed body part to be exposed in the thumbnail area, and the corresponding radiographed body part parameters are loaded to the exposure parameter area.

**NOTE:**

Click [Body Edit] to reset the exposure body parts. Body parts that have been filmed cannot be deleted.

3. Adjust the range of the light field according to the selected position.
4. (Optional) Use the parameter adjustment controls to adjust the exposure parameters if necessary.
5. Perform the exposure.

After image acquisition ends during the exposure process, the acquired image thumbnails are displayed in the thumbnail area and the exam will be displayed in the History screen.

**NOTE:**

You can delete the acquired images by the system administrator. Click the selected mark of the thumbnail, and click [Delete].

# 6 Image Browsing and Processing

---

On the exposure checking screen, you can browse the images acquired through exposure, process and diagnose the images, and determine whether to accept the images.

## 6.1 Image Display

The image display area displays the currently acquired images or history images.

A proportional scale is displayed on each image to reflect the size proportion between the display image and the actual image. The scale marks are adjusted in real time as the image is zoomed in and out, to reflect proportional changes.

The animal information area displays the current animal information.

The image displays the exposure parameters and radiation dose.



## 6.2 Thumbnail

The image thumbnail of the selected exam appears in the thumbnail area on the screen









- On the exposure checking screen: the current acquired images are displayed in the thumbnail area.
- On the history exam Screen: the images of the selected exam are displayed in the thumbnail area.

## 6.3 Image Operation

Common processing tools are provided for performing image display operations. The following figure shows the corresponding icons.

Icon	Name	Description
	Image roaming	In the image display area, click and drag the mouse to pan the image.
	Cropping	Crops images.
	Magnifier	Magnifies a portion of an image.



Icon	Name	Description
	Local window	Enables automatic window width and position in local areas.
	90° left rotation	Rotates left by 90°.
	90° right rotation	Rotates right by 90°.
	Up and down mirroring	Reverses image display up and down.
	Left and right mirroring	Reverses image display left and right.
	Rotation	Rotate the image at any angle.
	Positive/Negative image	Flips an image between positive and negative display.
	Animal Information Display	Displays animal details on an image, including the basic animal information and exposure parameters.
	Multi-cell Display Setup	Set the image layout.
/	Right mouse button	Adjusts the window width and position, and position identifier.
/	Save	Save the adjustment result to the image.
/	ReLmgPrc	Load the original image and reprocess the image with the default post-processing parameters of the current body position.

## Image Adjustment

Slide the screen in the image area to adjust the window width and position. Press and hold the right mouse key to adjust:

- Drag upward to reduce the window position value.
- Drag downward to increase the window position value.
- Drag to the left to reduce the window width.
- Drag to the right to increase the window width.

The current window width and position of an image are displayed in the lower-right corner of the image window.

When the local window exists, the internal window adjustment is applied to the local window image, and the external window adjustment is applied to the entire image. When the local window does not exist, the window adjustment is applied to the entire image in the image window.

## Cropping

Perform the following procedure:

1. Use the default crop box in the image or click  to select the crop size.
2. Adjust the crop box:

- Adjust the size: click and drag the 8 small boxes of the crop box area to adjust the crop box size.
- Adjust the position: move the mouse pointer to any of the four sides of the crop box, and after the mouse pointer turns into a hand shape, drag the crop box to move.

**NOTE:**

The maximum size of the crop box cannot exceed the image area.

3. Click [Save] to accept image cutting result.

Click [ReImgPrc] to restore the image to its original status.

## Magnifier

Click  to enter the magnifier state. Click the image area and hold the left mouse button to display the magnifier, which is used to zoom in on a local area of the image. Release the left mouse button to hide the magnifier.

## Rotate

Perform the following procedure:

1. Click .
2. Click the image area and hold the left mouse button to rotate clockwise or counterclockwise to rotate the image at any angle.

## Local Window

Click  to display the local window. The window width and position for image display in the local window are optimized for local images and different from those of the entire window.

## Positive/Negative Image Display

When browsing images, click  to display an image in positive or negative mode. To adapt to film interpretation habits, the system displays exposed images in negative mode by default.

## Animal Information Display

Click  to display or hide the animal exam information.

## Rotation and Mirroring

You can rotate and mirror images during image browsing by using , including 90° left/right rotation and up/down mirroring. During rotation and mirroring, the marks and tags of the image change their positions accordingly, but they do not flip over or rotate.

## Image Scaling

Scroll the mouse wheel in the image display to zoom in or out on an image.

## Image Panning

In the image display area, click and drag the mouse to pan the image.

## Paging

When images are displayed on multiple pages, click  or  to turn to the previous or next page to view the images on each page.

The page number is displayed between the paging buttons. The first digit indicates the current page number, and the second digit indicates the total pages.

## Multi-cell Display Setup

Click the multi-cell display button , and the supported display formats are displayed for selection.







## 6.4 Annotation

### WARNING

**You must ensure that the entered comments are correct. Incorrect comments may lead to misdiagnosis.**

Comments can be added to an image to bring attention, annotate or communicate information observed during the examination.

The following table lists the comment buttons and functions.

Icon	Name	Description
	Left Position Identification	/
	Right Position Identification	/
	More Position Identification	Click to select “DV”, “VD” and input the custom position identification.
	Text Annotation	Click to enter text annotation status.
	Clear	Click to clear the selected text annotation.
	Clear All	Click to clear all text annotations.
	Arrow	Click to enter arrow annotation status.

### 6.4.1 Position Identification

The position identifiers in the right part of the screen include L (left), R (right), DV (Dorsoventral), VD (Ventrodorsal), and custom tags.



Perform the following procedure:

- To add a position identifier: click a position identifier button to add the position identifier to the image.  
Click  to add “DV”, “VD” or custom tags.
- To move the position identifier: select the position identifier on an image and drag and drop the identifier to change its position on the image. When an image is saved, the added position identifier is rasterized to the image.
- To cancel the position identifier: a position identifier button in selected state is in highlighted color. When the button is clicked again, the position identifier is not added.  
Click [ReImgPrc] to remove all position identifiers on the image.
- Click [Save] to save the position identifier to the image.

## 6.4.2 Text Annotation



### Adding Text Annotations

Perform the following procedure:

1. Click  to enter the text annotation status.  
Character cursor appears on the image.
2. Move the cursor to the position to be added, and click to confirm the target position.
3. Use the keyboard to enter a character comment.  
Press <Enter> to move the cursor to the new line.
4. Click  again to exit the text annotation status.





### Editing Text Annotations

Perform the following procedure:

1. Click  to enter the text annotation status.
2. Move the cursor to the text annotation to be edited, and click to select.
3. Use the keyboard to edit the text annotation.
4. Click  again to exit the text annotation status.

### Deleting Text Annotations







Perform the following procedure:

1. Click  to enter the text annotation status.
2. Deleting annotations:
  - To delete one text annotation: move the cursor to the text annotation and double-click, and there is a frame around the selected text annotation.  
Click  or press <Del> button on the keyboard.
  - To delete all text annotations: Click .
3. Click  again to exit the text annotation status.

## 6.4.3 Arrow Annotation







### Adding Arrow Annotations

Perform the following procedure:

1. Click  to enter the arrow annotation status.
2. Click and drag on the image to move the arrow to the target position.
3. Click [Modify], shape and angle adjustment marks  appear on both ends of the arrow and position adjustment mark  appear in the middle.
  - To adjust the shape and angle: click and drag  to adjust to the desired orientation.
  - To adjust the position: click and drag  to move the arrow to the target position.
4. Click  again to exit the arrow annotation status.



### Editing Arrow Annotations

Perform the following procedure:

1. Click  to enter the arrow annotation status.
2. Click [Modify], shape and angle adjustment marks  appear on both ends of the arrow and position adjustment mark  appear in the middle.
  - To adjust the shape and angle: click and drag  to adjust to the desired orientation.
  - To adjust the position: click and drag  to move the arrow to the target position.
3. Click  again to exit the arrow annotation status.

### Deleting Arrow Annotations

Perform the following procedure:

1. Click  to enter the arrow annotation status.
2. Delete arrow annotations:
  - To delete one arrow: click [Clear Last] to delete the recently-added arrow. Repeat this operation to delete the added arrows chronologically.
  - To delete all arrows: click [Clear All].
3. Click  again to exit the arrow annotation status.

## 6.5 Measurements

---

### WARNING

**Be sure to measure areas of interest from the most optimal image plane to avoid misdiagnosis from inaccurate measurement values.**

---

## CAUTION

- Select the proper animal image and measurement tools. Only qualified professionals can decide the appropriate measurements and results.
- Confine measurement calipers to the actual Region of Interest (ROI). Measurements that extend beyond the ROI will be incorrect.
- Using the [Clear All] will clear the measurement caliper and all data in the result window.

There are two kinds of measurement tools: Routine and Application.

### 6.5.1 Basic Operations and Buttons

The following descriptions for buttons and buttons are used during performing measurements:

Buttons	Basic Operations
Left mouse button	Click the item in the measurement menu. During the measurement, press the left mouse button to confirm the current operation and proceed to the next operation.  <i>NOTE:</i> Unless otherwise specified, “Click” refers to “press the left mouse button.”
Mouse	Move the cursor.

### 6.5.2 Measurement Menu

#### **TIP:**

A measurement tool can be activated by selecting the item on the touch screen. It is described as “Select... in the measurement menu” in the following procedures.

Shortcut buttons of measurement items are as shown in Figure 6-1.

**Figure 6-1 Shortcut Buttons of Measurement Items**

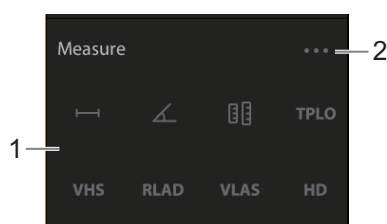

1.	Shortcut buttons of measurement items.
2.	Measurement Menu

Select the measurement shortcut button to enter the measurement menu. Take Routine measurement menu as example, measurement menu is shown in Figure 6-2.

**Figure 6-2 Measurement Menu**

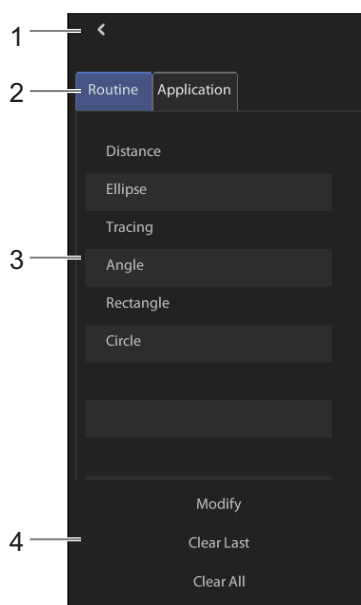

1.	Click to exit the measurement status.
2.	Click to select between the routine measurement menu and application measurement menu.
3.	Click the measurement item to start the measurement.  <i>NOTE:</i> Some measurement tools have multiple methods to select.
4.	<ul style="list-style-type: none"> <li>• Click [Modify] to enter the measurement editing status.</li> <li>• Click [Clear Last] to delete the latest measurement.</li> <li>• Click [Clear All] to clear all measurements.</li> </ul>

### 6.5.3 Measurement Caliper

A measurement caliper is a graphic consisting of several points and a straight line or curve drawn on the image.

#### Fixed/Active End

The ends of calipers can be active or fixed. The active end is called a Cursor.

#### Caliper Color

An active caliper appears green, while a fixed one appears white in the system default preset.

#### Caliper End Number

Different caliper end numbers are displayed in the caliper end and results window to distinguish different measurements.

## 6.5.4 Results Window

The measurement window displays the conducted measurement's result and the engaging measurement in real time.

### Results Display

The latest results display in the results window in time sequence.

- When viewing the results: If the results window is full, the oldest value will be replaced according to the "first in, first out" rule.

A maximum of 8 results can display in the results window.

- To identify the measurement results, numbers are used in the numerical results window.

### Moving the Results Window

To move the results window:

1. Place the cursor on the results window and click and hold to drag the result window to the desired position.
2. Release the left mouse button to fix the results window.

## 6.5.5 Routine Measurements

### Distance

Measures the distance between two points on the image.

Perform the following procedure:

1. Select [Distance] in the measurement menu.
2. Determine the starting point of the position to be measured on the image, and then click.
3. Move the cursor to the end point and click to set the end point and the result displays in the results window.
4. If needed, click [Modify] to enter the measurement editing status.
  - Click and drag  on the measurement caliper to adjust the position of the end point.
  - Click and drag  on the measurement caliper to adjust its position.

### Ellipse

Measures the area and circumference of an ellipse region on the image

Perform the following procedure:

1. Select [Ellipse] in the measurement menu.
2. Determine the starting point of the first axis of the ellipse on the image, and then click.
3. Move the cursor to the desired point and click to set the end point of the first axis of the ellipse.  
The second axis appears on the screen.



4. Moving the cursor will increase or decrease the ellipse from the fixed axis. Move the cursor to trace the area of interest as closely as possible.
5. Click on the image to anchor the ellipse region.
6. If needed, click [Modify] to enter the measurement editing status.
  - Click and drag  on the measurement caliper to adjust the position of the end point.
  - Click and drag  on the measurement caliper to adjust its position.

## Trace

Measures the area and circumference of a closed region on the image.

Perform the following procedure:

1. Select [Trace] in the measurement menu.
2. Determine the starting point on the image, and then click.
3. Move the cursor along the target to trace the outline of the target.
4. Click and the trace line will be closed with a straight line connecting the start and end points.

The trace will also be closed when the cursor is very near to the starting point.
5. If needed, click [Modify] to enter the measurement editing status.
  - Click and drag  on the measurement caliper to adjust the position of the end point.
  - Click and drag  on the measurement caliper to adjust its position.

## Angle

Measures the angle of two crossing planes on the image and the range is: 0° to 180°.

Perform the following procedure:

1. Select [Angle] in the measurement menu.
2. Set two line segments as described in *Distance* section above.

The angle appears in the results window after setting the line segments.
3. If needed, click [Modify] to enter the measurement editing status.
  - Click and drag  on the measurement caliper to adjust the position of the end point.
  - Click and drag  on the measurement caliper to adjust its position.

## Rectangular

Measures the pixel average and standard deviation on the rectangular.

Perform the following procedure:

1. Select [Rectangle] in the measurement menu.
2. Determine the starting point on the image, and then click.
3. Move the cursor to the target point and click.

The pixel average and standard deviation appear in the results window.

4. If needed, click [Modify] to enter the measurement editing status.
  - Click and drag  on the measurement caliper to adjust the position of the end point.
  - Click and drag  on the measurement caliper to adjust its position.

## Circle

Measures the area and circumference of a circle region on the image.

Perform the following procedure:

1. Select [Circle] in the measurement menu.
2. Click on the image, the cursor appears on the screen.
3. Move the cursor to the target area and click to confirm the circle position.
4. Click on the image to anchor the ellipse region.
5. If needed, click [Modify] to enter the measurement editing status.
  - Click and drag  on the measurement caliper to adjust the position of the end point.
  - Click and drag  on the measurement caliper to adjust its position.

## 6.5.6 Application Measurements

### Geometric Correction

The image will be magnified in the process of image generation. The function of geometric correction is to reduce the measurement error by correction.

Perform the following procedure:

1. Select [Geometric Calibration] in the measurement menu.
2. Draw a calibration line to display the length of the line.

The measurement correction line has the same function as the “Distance” measurement.

After the calibration line is drawn, a dialog box pops up to prompt the user to input the actual length of the calibration line.

**NOTE:**

Click [Cancel] in the input box to clear the correction line and exit the geometric correction function.

3. Click [Correct] to correct the current caliper.

After the calibration is completed, the scale changes accordingly, and the icon “Geometric correction” is displayed beside the scale, indicating that the calibration has been performed.

The calibrated effect is valid for all measurement items. For example, the display length of the measurement calibration line becomes the input length of the user.

Click [Geometric Calibration] again to clear the last geometric correction result and restart the function.

## VHS Measurement

Perform the following procedure:

1. Select [VHS] in the measurement menu.

There are six adjustable nodes (p11, pl2, ps1, ps2, pv1, pv2) in the image.

2. Cardiac long axis (L):

Place the first point p11 at the ventral border of the bifurcation of the left main bronchus and the second point pl2 at the apex, which reflects the overall size of the left atrium and left ventricle.

3. Measure short axis of heart (S):

The vertical line of the long axis is drawn from the midpoint where the posterior border of the heart intersects the posterior vena cava. Points ps1 and B2 are placed at the two intersection of the vertical line and the heart contour, respectively.

4. Measure VHS:

Place point pv1 at the most anterior end of the fourth vertebra and adjust the pv2 so that the VHS measurement line is parallel to the cone.

---

### **NOTE:**

- Line segments p11pl2 and ps1ps2 have a vertical relationship.
  - The VHS measurement line consists of two parallel segments, aligned at the pv1 end, and their lengths change with p11pl2 and ps1ps2 respectively, which are the same.
- 

## VLAS (vertebral left atrial size) Measurement

Perform the following procedure:

1. Select [VLAS] in the measurement menu.

VLAS tools appear in the image, providing four adjustable nodes: Pa1, pa2, pv1 and pv2.

2. Measure Left Atrium (A):

Place the first point pa1 on the ventral end of the left and right branches of the main trachea, and the second point pa2 on the left atrium at the junction of the posterior vena cava and the dorsal side of the posterior vena cava.

3. Measurement VLAS:

Place point pv1 at the most anterior end of the fourth vertebra and adjust the pv2 so that the VLAS measurement line is parallel to the cone.

Reference range: Normal range: 1. -2.2 7. An  $\geq 2.3$  indicates dilated left atrium.(Increase)

### **NOTE:**

The length of VLAS measurement line varies with the length of pa1pa2 and is equal to it.

## RLAD (Rradiographic left atrial dimension) Measurement

Perform the following procedure:

1. Select [RLAD] in the measurement menu.

The RLAD tool appears in the image, providing seven adjustable nodes: P11, pl2, ps1, ps2, pa1, pv1, pv2.

2. Measure cardiac long axis (L):

Place the first point pl1 at the ventral border of the bifurcation of the left main bronchus and the second point pl2 at the apex, which reflects the overall size of the left atrium and left ventricle.

3. Measure cardiac short axis (S):

The vertical line of the long axis is drawn from the midpoint where the posterior border of the heart intersects the posterior vena cava. Points ps1 and B2 are placed at the two intersection of the vertical line and the heart contour, respectively.

4. Measure the left atrial boundary:

Place point pa1 at the border of the left atrium.

5. Measure RLAD:

Place point pv1 at the most anterior end of the fourth vertebra and adjust the pv2 so that the VHS measurement line is parallel to the cone.

Reference range: Greater than 1.8 indicates dilated left atrium (Increase)

**NOTE:**

- Line segments pllpl2 and ps1ps2 have a vertical relationship.
- One end of segment A is fixed at the intersection of pllpl2 and ps1ps2 and at an angle of 45° with the short axis of the long axis. Adjust pa1 to determine this segment.
- The RLAD measurement line consists of three parallel segments aligned at the pv1 end. The length of the three segments changes with the pllpl2, ps1ps2, and (the intersection of pa1 and pllpl2, ps1ps2), and is equal to them.

## TPLO Measurement

Perform the following procedure:

1. Select [TPLO] in the measurement menu.

The TPLO tool appears in the image.

2. Mark the two points: Ps1 and ps2 at the edge of the tibial plateau.

3. Mark the two points: The pl1 of the tibial plateau and the pl2 of the accessory bone joint. At the intersection with segment ps1ps2, the vertical line of segment pl1pl2 is displayed by a dotted line.

4. Mark the center and radius of the cut tibial head with two points. Modify the center position and radius.

Final measurement result:

TPA = Angle between the vertical lines of segment ps1ps2 and pl1pl2 of segment

Saw Radius (osteotomy radius): Radius of the circle

## HD Measurement

Perform the following procedure:

1. Select [HD] in the measurement menu.  
 HD tool appears in the image.
2. Adjust the center and radius, and place the center of the two circles on the center of the two femurs.
3. Dragging P1 generates segment c1p1 in real time, placing P1 on the anterior border of the acetabulum.
4. Dragging P2 generates segment c2p2 in real time, placing P2 on the anterior border of the acetabulum.

Final measurement result:

Angle between segment c1p1 and c1c2, angle between segment c2p2 and c1c2.

A smaller angle indicates greater joint laxity.

## 6.6 Image Postprocessing

By default, the following image postprocessing solutions are provided: enhancement 1, enhancement 2, and enhancement 3, with a decreasing level of enhancement. Enhancement 1 generates images with the highest contrast and sharpest effect, whereas enhancement 3 generates images with the weakest contrast and softest effect.

On the exposure checking screen, click [Adv Proc], the parameter adjustment subpane is displayed, as shown in Figure 6-3. You can adjust the image postprocessing parameters.

**Figure 6-3 Image Postprocessing Menu**

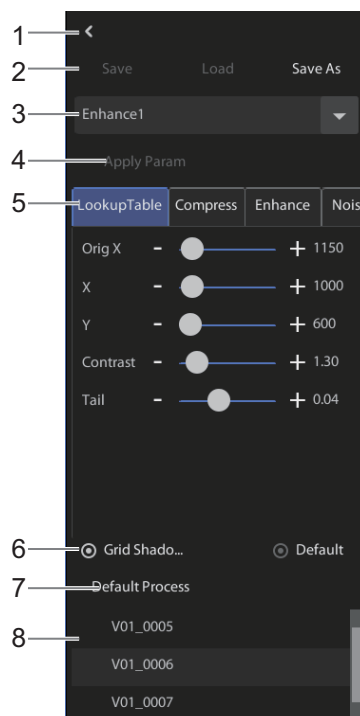

1.	Click to exit the image postprocessing menu.
2.	<ul style="list-style-type: none"> <li>• [Save]: to save the set parameters. The saved parameters will be the default ones for the next exam.</li> <li>• [Load]: to restore the default parameters and reprocess the image.</li> <li>• [Save as]: to save the current parameter as a set of custom parameters. After clicking the button, the input parameter naming dialog box is displayed.</li> </ul>
3.	Click the drop-down box to select the enhanced processing solution.
4.	Click to apply the parameter adjustment to the selected image.
5.	<p>Click to switch among different parameter groups. The corresponding parameter adjustment panel is displayed.</p> <p>The parameters can be adjusted by dragging the slider horizontally or clicking the Increase and Reduce buttons</p>
6.	Set whether to implement grid shadow suppression on the image.
7.	Click to load the original image and reprocess the image with the default post-processing parameters of the current body position.
8.	Load the default postprocessing parameters of the selected body part.

### Optimization Curve Adjustment (Look-up Table)

You can change the global image effect by adjusting the optimization curve, to achieve the desired image quality. The optimization curve is determined by the control point position, slope of the curve passing the control point, and the optimization parameters for the curve endpoint.

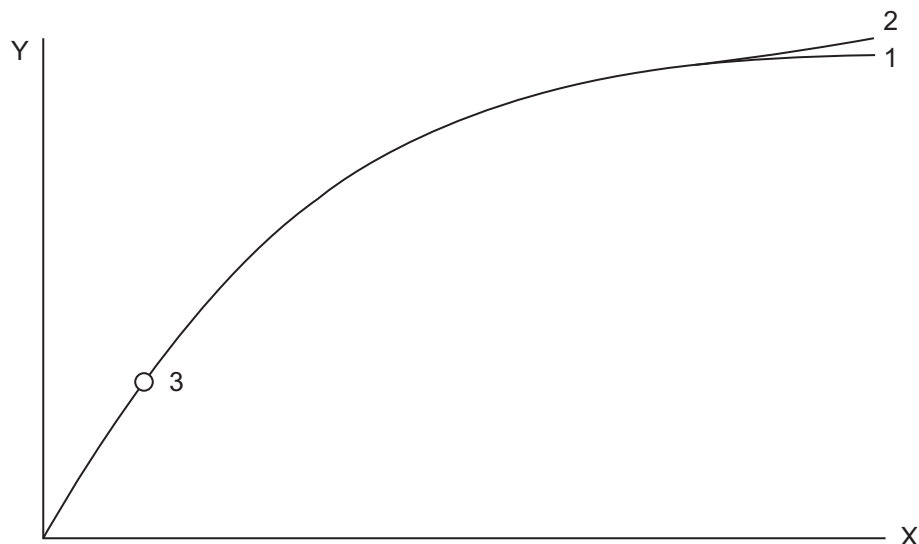

X axis	Input pixel
Y axis	Output pixel
1	Tail end parameter 1

2	Tail end parameter 2
3	Control

The specific adjustment parameters are as follows:

Parameter	Description
X-axis (brightness) of the optimization curve control point	You can change the value of Brightness to adjust the image brightness. Increase the parameter value, and the entire image (including bone tissue and soft tissue) becomes brighter. Reduce the parameter value, and the entire image becomes dimmer.
Y-axis of the curve control point	Change the y-axis to change the display effect of the soft issue on the image. When Y is changed to a smaller value, the soft tissue on the image becomes brighter. When Y is changed to a greater value, the soft tissue on the image becomes dimmer.
Slope (contrast) of the curve control point	Change the value of Contrast to change the global contrast of an image.
Curve endpoint optimization parameter (Tail)	This parameter is used to change the shape of the curve tail, in order to change the display effect and customization of the soft tissue close to the background. Compared with tail parameter 1 of the curve, tail parameter 2 displays more soft tissue close to the background.

### Dynamic Compression

You can reduce the dynamic range of an image to display more specific information.

Parameter	Description
Dynamic compression	You can reduce dynamic compression to reduce the change range of overall brightness trend of the image and reduce the significant black-and-white difference.
Parameter beta	This parameter is used to change the display range of the high-density tissue area (which corresponds to the white part of the image), in order to improve the display details.

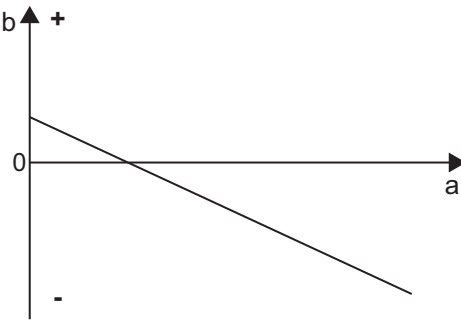
Parameter	Description
Compensation factor	<p>This parameter is used to control the correction degree of the gray value. The following figure shows how the corrected value changes with the gray value.</p>  <p>a: Gray value; b: Correction value</p>

### Detail Enhancement

Detail enhancement only changes the local detail contrast of an image. It does not affect the global display effect.

Parameter	Description
Size 1	This parameter is used to change the thickness of the corresponding side to the contrast of a detail (such as trabecular bone) of the pixel size of a source image. The smaller the parameter value, the higher the enhancement level, and vice versa. When the parameter is set to 1.0, the details of the specific layer are not enhanced. The detailed graph of the layer contains many noises. Therefore, the noises are increased when the details are enhanced.
Size 2	This parameter is used to change the thickness of the corresponding side to the contrast of a detail of the pixel size of two source images. The detailed layer graph corresponding to the parameter also contains many noises. The noise size is greater than that of Size 1 and therefore is of greater granularity.
Size 3	This parameter is used to change the thickness of the corresponding side to the contrast of a detail of the pixel size of four source images. The noises corresponding to the parameter are less than those of Size 1 and Size 2. However, the noise size of Size 3 is greater than those of Size 1 and Size 2 and therefore is of greater granularity. The noises of great granularity are increased when the detail contrast of the layer graph is enhanced.
Size 4	This parameter is used to change the thickness of the corresponding side to the contrast of a detail of the pixel size of eight source images. The layer graph corresponding to the parameter contains few noises. Therefore, no obvious noises are caused when the layer graph is enhanced.
Size 5	This parameter is used to change the thickness of the corresponding side to the contrast of a detail of the pixel size of 16 source images. The layer graph corresponding to the parameter contains no noises.



Parameter	Description
Size 6 and Size 7	These two parameters are used to change the thickness of the corresponding side to the contrast of a detail of the pixel size of 32 and 64 source images, respectively. When the values of Size 5, Size 6, and Size 7 are reduced, the contrast between large tissues is increased whereas the noise display is less obvious.
Enhancement factor	The value ranges from 0 to 3.5. It is an overall adjustment value of image enhancement. The smaller the value, the lower the sharpness and the softer the image is. The greater the value, the higher the sharpness and contrast are, and the clearer the details.

## Noise Suppression

Noise suppression is used to suppress the image noise and smooth the image.

Parameter	Description
Noise reduction levels	<ul style="list-style-type: none"> <li>• 0: No noise reduction</li> <li>• 1: Minor noise reduction</li> <li>• 2: Moderate noise reduction</li> <li>• 3: Major noise reduction</li> </ul>
Noise criterion	Distinguishes between noises and details. When the contrast between a pixel in a detailed layer graph and another pixel in the surrounding area is less than the noise criterion value, the pixel in the surrounding area has great impact on the noise reduction of the current pixel. Otherwise, the pixel in the surrounding area has minor impact on the noise reduction of the current pixel. In this case, the details between the two pixels are retained.
Sigma	Controls the impact on noise reduction that is caused by the pixels near the current pixel. When the distance between the surrounding pixels and the current pixel is the same, a greater parameter value indicates less impact on noise reduction that is caused by the surrounding pixels, and vice versa.
Fine-grained suppression parameter	Suppresses fine-grained noises. Noise suppression reaches the maximum level when the parameter value is 0, and reaches the minimum level (noise is not suppressed) when the parameter value is 1.0. When the parameter value changes gradually from 0 to 1, the level of noise suppression decreases.
Medium-grained suppression parameter	Suppresses medium-grained noises. Noise suppression reaches the maximum level when the parameter value is 0, and reaches the minimum level (noise is not suppressed) when the parameter value is 1.0. When the parameter value changes gradually from 0 to 1, the level of noise suppression decreases.
Coarse-grained suppression parameter	Suppresses coarse-grained noises. Noise suppression reaches the maximum level when the parameter value is 0, and reaches the minimum level (noise is not suppressed) when the parameter value is 1.0. When the parameter value changes gradually from 0 to 1, the level of noise suppression decreases.

## Auto WL Ratio

The related parameters of the auto window factor can affect the result of the auto calculated window level. The auto window left scale factor adjustment will increase the left end position of the window, the auto window right scale factor adjustment will decrease the right end position of the window, and the auto window adjustment will increase the overall position of the window.

## Simplified Parameter Mode

Parameter	Description
Brightness	The smaller the value, the dimmer the image. The greater the value, the brighter the image.
Contrast	The smaller the value, the weaker the image contrast and layering effect. The greater the value, the higher the image contrast and layering effect.
Sharpness	The smaller the value, the weaker the image sharpness and less details. The greater the value, the higher the image sharpness and more details.
Noise reduction	The smaller the value, the stronger the image noise. The greater the value, the weaker the image noise.

## 6.7 Image Stitching

The console software provides the image stitching function to stitch the images of body parts such as the spine and legs of the animal in different areas to form a complete single image.

### 6.7.1 Starting Stitching Management

Perform the following procedure:

1. Select the images to be stitched (the selected images are marked) on the exposure checking screen.
2. Click [Stitch] to start stitching management.

The stitched image is automatically saved and displayed in the thumbnail area.

The stitching position can be adjusted manually through image panning and stitching point selection.

Click [Edit Stitch] to switch to the main screen of image stitching.

The main screen of image stitching mainly consists of the following functional areas:

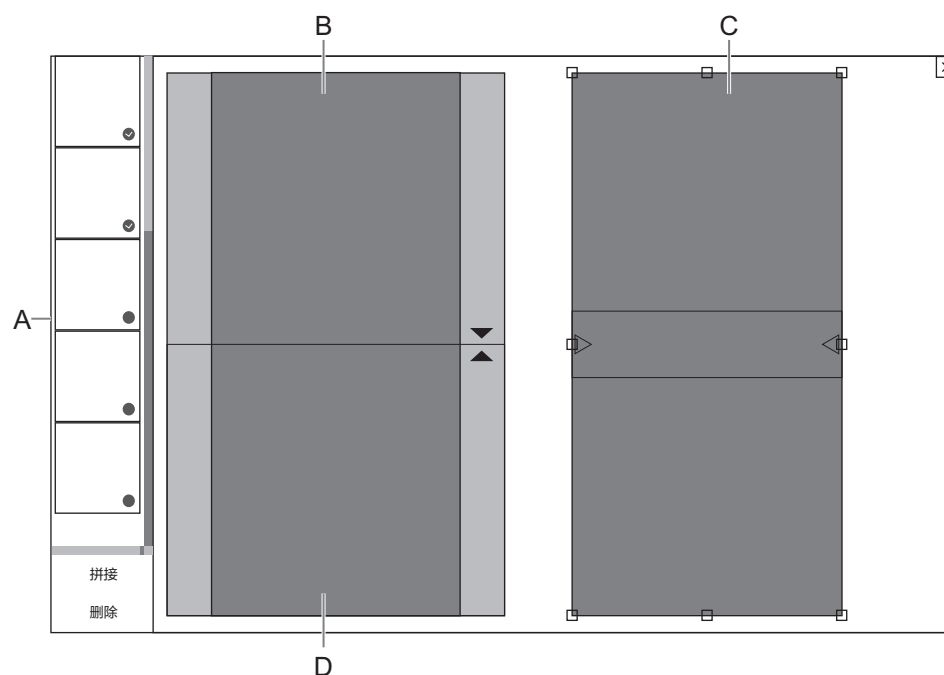

A	Thumbnail management area: displays the thumbnails of the stitched images.
B	Area 1 of image stitching: displays the upper image corresponding to the current stitching seam.
C	Stitching result display area: displays the overall stitching effect.
D	Area 2 of image stitching: displays the lower image corresponding to the current stitching seam.

You can perform, adjust, and confirm stitching using the following controls

	Moves the selected image upward. If the selected image is on top, no operation is performed.
	Moves the selected image downward. If the selected image is at the bottom, no operation is performed.
Delete the selected source image	Deletes the selected image.
Select Coincident Point	Selects the stitching point between images in area B and area D.
Body thickness	Indicates the maximum distance between the front and rear surface of the body.
SID	Indicates the distance between the center of the body and the surface of the FPD.
Fusion	Indicates the degree of simultaneous display of two neighboring images in the overlap area.

Recalculate	If the automatic stitching results do not meet your expectation, you can click [Restitch] to enter the manual stitching state.  You can also discard the manual stitching results and restore to the initial state of automatic stitching.
Save	Accepts the current stitching results, saves the stitched image, and saves the image to the database.

## Image Panning

Image panning is the process of manually moving two images to be stitched relative to each other to adjust the stitching position.

Perform the following procedure:

1. Observe the stitching rendering in area C to identify the area to be adjusted.

You can also observe the thumbnails in area A to determine the approximate position of the stitching seam. Areas B and D display the upper and lower images corresponding to the selected stitching seam and the stitching relationship.

2. Click in the area D, a blue box is displayed.
3. Click and drag the mouse to pan the image in area D to adjust the stitching position of the images in area B and area D, and observe the adjustment effect in area C.

Release the mouse after adjustment.

4. Repeat steps 1~3. if you want to continue to adjust the stitching relationship between other neighboring images.
5. After adjusting the stitching of all images, click [Save] to save the images.

## Stitching Point Selection

Coincident point selection is the method of adjusting the stitching position by superposing the stitching points of two images.

Perform the following procedure:

1. Observe the stitching rendering in area C to identify the area to be adjusted.
2. Click in the area D, a blue box is displayed.
3. Click [Select Coincident Point] on the main screen of image stitching.

4. Click the images in area B and area D to select the stitching points.

The selected stitching points are marked by a red cross.

5. Click [Recalculate].

The system combines the images in area B and area D by superposing the stitching points. You can observe the adjustment effect in area C. If the stitching effect does not meet your expectation, click [Select Coincident Point] to reselect stitching points.

6. Repeat steps 1~5. if you want to continue to adjust the stitching relationship between other neighboring images.

7. After adjusting the stitching of all images, click [Save] to save the images

## **6.8 Image Confirmation**

The images generated during exposure are automatically saved.

After images are tagged or postprocessed (adjusted), click [Save] to save the images. Click [Save As] to save an image as a new image. The originally saved image remains unchanged.

---

***NOTE:***

Click [Cancel] to return to the status when the image is saved.

---

# 7 Animal Data Management

---

An exam record consists of all information and data of one exam. An exam record consists of the following information:

- Animal basic information and exam data
- Image files
- Report

Click [History] to enter the history image screen. The screen provides the following functions:

- Query and display animal information
- Edit animal information
- Delete animal information
- Send and print animal images
- Back up and restore animal data

---

**NOTE:**

- DO NOT use the internal hard drive for long-term image storage. Daily backup is recommended. External storage media is recommended for archiving images.
  - The system animal database space is limited, please back up or clear animal data in time.
  - Selecting the compressed format to export the image may cause image distortion.
  - The manufacturer is not responsible for lost data if you DO NOT follow suggested backup procedures
- 

## 7.1 Searching an Animal

Perform the following procedure:

1. Select the data source.

Select [Data Source] to select the data source of animal data, the system animal database is default.

2. Set search conditions in the “Item” drop-down list.
3. Enter the key word. The matching animal information is displayed in the animal list.

When you select an animal in the animal list, the images of this animal will be displayed at the bottom of the screen.

## 7.2 Animal Data View and Management

Select the desired animal information in the list.

Item	Description
Backup	Back up the selected animal data to the system-supported media. You can select whether to remove the exam record from the system.
Restore	Import the animal data from an external media.
Lock	Lock the selected animal exam. The locked animal examination cannot be deleted.
Edit	View the details of the animal and modify the animal information.
Delete	To delete an exam: select the desired exam and click [Delete] below the animal information list area.  <b>NOTE:</b> Only administrators or authorized operators are allowed to delete data.
Delete	To delete an image:  <b>1.</b> Select an animal exam. The image(s) acquired by the exam is displayed in the thumbnail area. <b>2.</b> Click [Delete] on the right of the thumbnail area, and select the image(s) to be deleted. <b>3.</b> Click [OK].  <b>NOTE:</b> Only administrators or authorized operators are allowed to delete data.

## 7.3 Image Compare

On the exposure checking screen, click [Diag Ref].

The title bar of the left image displays the current animal ID, animal name, and animal type.

There are 4 tabs on the right, which are “History”, “Standard”, “Pathology” and “App Meas”.

### History Image

- Click [History] tab. The history image library of the previous exam with the same animal ID is loaded by default. The first image with the same position on the left is displayed. The right title bar displays the currently referenced animal ID, animal name, and animal type.
- Click [History] again to display all thumbnails of the current exam. Click a thumbnail to load the image to the right image display area.
- A search bar is provided on the right side of the title bar. The search method equals to fuzzy search when [All] is selected in the history image. The search result is an exam that meets the requirement. Click to select an exam to load the image of the exam.

## Standard Image

Click [Standard] tab, and the standard slice of the left image is displayed by default. The right title bar displays the position of the current standard slide.

Click the [Standard] tab again to display the thumbnails of all optional standard sheets. Click a thumbnail to load the image to the right image display area.

## Pathological Image

Click [Pathology] tab. The image on the left of the tab is loaded by default, and the first one on the right of the tab is displayed in the image display area. The right title bar displays the symptoms corresponding to the current pathological slice.

Click [Pathology] again to display the thumbnails of all the images. Click a thumbnail to load the image to the right image display area.

## Application Measurement

Click [App Meas], and the first application measurement image is displayed by default. The title bar on the right side displays the name of the application measurement.

Click [App Meas] again to expand the thumbnails of all application measurements. Click a thumbnail to load the image to the right image display area.

## 7.4 Sending Animal data

Perform the following procedure:

1. Select one or more animal exams from the animal information list.
2. Click [PACS] below the animal information list area to send all the images of the selected animal to the PACS.

## 7.5 u-Link (applicable for CE region only)

u-Link is used to connect the ultrasound system with software applications which support the u-Link protocol.

## 7.6 Recycle Bin

The recycle bin is used to store deleted animal data, exam data and images.

The system supports recovery of these data from the recycle bin.

Click [Recycle Bin] to enter the Animal Recycle Bin screen.

Select items to be recovered in the list.

- [Restore]: to restore the selected item back to history exam.
- [Delete]: to delete the item permanently, and the item can never be restored again.



## 7.7 Image Print

On the history exam screen, select the desired exam to be printed, and click [Print] to enter the image print management screen.

The print management function allows you to arrange the layout of and adjust the received images. The following print operations are available: print node, film orientation, film size, image typesetting format, image removal, and film removal.

### 7.7.1 Thumbnail Area Operations

#### To add an image to a film

Do one of the following to add an image:

- Double-click a thumbnail to add the image to the first empty film cell. When no empty film exists, an empty film is automatically created and the image is added to the film.
- Click a thumbnail, and drag and drop it to the target film cell. Then, the image is added to the cell.

#### To scroll to display thumbnails







When thumbnails are displayed on more than one page, you can drag the thumbnail area for position adjustment. You can also click the up and down arrows for position adjustment.



#### To clear thumbnails

Click [Clear] to clear the image(s) in the thumbnail area.

### 7.7.2 Image Adjustment





You can adjust the image in the image preview area before printing. The adjustment functions are the same as those on the image browsing screen, including:



Icon	Name	Description
	Image roaming	In the image display area, click and drag the mouse to pan the image.
	Rotation	Rotate the image at any angle.
	Image dragging	After clicking this button, click in the image preview area to exchange images between different cells and films by dragging and dropping.
/	Default	Restores an image to the state prior to adjustment.
	Animal information display	Displays animal details on an image, including the basic animal information and exposure parameters.
	Positive/Negative image	Flips an image between positive and negative display.
	90° left rotation	Rotates left by 90°.

Icon	Name	Description
	90° right rotation	Rotates right by 90°.
	Up and down mirroring	Reverses image display up and down.
	Left and right mirroring	Reverses image display left and right.

### 7.7.3 Print Typesetting

The following table lists the functions and operations of typesetting tools:

Icon	Name	Description
	Print Format	Click different icons to select different print formats.  When you switch a print format, the left-side page is adjusted accordingly. The following figure shows the examples of various print formats.
14*17	Film size	You can select the desired film size. When the current film size is changed, the image added to the film changes its zooming status.
	Film orientation	Click different icons to select film print orientations.  After a film print orientation is selected, the layout of the left-side page is rearranged accordingly. When the current orientation is changed, the image added to the film changes its zooming status.
	Multi-film preview	Select the film preview window format.
/	New Film	Click to add a new and empty film to the image preview area on the left as the last page.  By default, the new film adopts the currently selected format.
/	Del Img	In the film preview window, click a film cell of the image to be deleted.  <b>NOTE:</b> Click the  icon on top right of the film grid to delete the image in the current film cell.
/	Del Film	Click to delete the current film. The total number of film pages reduces by 1.  When the film preview window displays only one film, the displayed film is the current film. When the film preview window displays multiple films, the current film is highlighted.
/	Del All	Click to delete all films. Then, the total number of film pages becomes 0.

Icon	Name	Description
	Paging	<p>When films are displayed on multiple pages of the printing screen, click  or  to turn to the previous or next page to view the films on each page.</p> <p>The page number is displayed between the paging buttons. The first digit indicates the current page number, and the second digit indicates the total pages.</p>

## 7.7.4 Thumbnail Area Operation

### Setting a Print Node

By default, the Print Node drop-down list displays the default node in the *Setup* chapter.

When no default node is configured, the first node is displayed by default.

When multiple nodes are configured, select one from the drop-down list.

### Setting the Number of Printed Copies

- Click [+] to increase the number of printed copies. Up to 10 copies can be printed.
- Click [-] to reduce the number of printed copies. The number of copies is displayed in the middle.

### Setting Image Fit Format

- Adaptive printing  
When you create a film on the film management screen, [Auto Fit] is selected by default. Adaptive printing indicates that the added image fills the film entirely.  
The image automatically adapts itself to the film cell size to fill the cell entirely when you change the film size, film orientation, and film typesetting, or rotate and flip the image on the film
- Equal-proportion printing  
Equal-proportion printing indicates that an image is printed to a film in a specific proportion of the actual image size. For example, if the 1.0 proportion is selected, the image printed to the film is of the actual size. Select [Actual Size], and select an option from the proportionality factor drop-down list.
- Apply to all  
Switching between adaptive printing and equal-proportion printing applies only to the current film. After you click [Apply to All], adaptive printing or equal-proportion printing selected for the current film is applied to all the other films.

## 7.7.5 Print

### Printing the Current Film

Click [Print Current] to print the current film to the selected printer node.

### Printing All Films

Perform the following procedure:

1. Click [Print All] to print all films to the selected printer node.

You are prompted for operation confirmation before actual printing.

2. Click [OK] to start printing; click [Cancel] to cancel the printing.

## 7.8 Animal Task Management

Select  in the system status icon area of the screen to bring up the task management dialog box.

You can perform the following operations:

- Select [Delete] to delete the task.
- Select [Retry] to retry the failed task.

## 7.9 DICOM Task Management

Select  in the system status icon area of the screen to bring up the DICOM task management dialog box.

Perform the following procedure:

1. Select task type: Storage, Print and All.
2. Set search conditions:
  - Select task status.
  - Select the time range.
3. Click [Query] to view the tasks.
4. Perform the following operations:
  - Click [Delete] to delete the selected task.
  - Click [Redo] to retry the failed task.

# 8 Report Management

---

Click [Report] in the Exam process icons area to enter the report management screen.

## 8.1 Select a Report

Perform the following procedure:

1. On the report management screen, click  (Report list button) to expand the history report list:
  - “No reported” tab: check the list of unsaved reports.
  - “Reported” tab: check the list of saved reports.

2. Search a report:

Select the query conditions and input the query keyword in the text box to fuzzy search for the animals meeting the conditions.

Click  to restore the default query conditions and view the animals that are examined on the current day.

3. In the queried report list, select the report to be edited to enter the report editing screen.
4. Click  (Report list button) to close the history report list.

## 8.2 Edit a Report

### 8.2.1 Modifying Animal Information

In the animal information area, the bed number and examined parts can be edited. Click the blank area behind bed number to edit information.

To edit animal information, click [Edit] button on the history exam screen.

### 8.2.2 Adding Images

When an animal exam report is selected, the image of the animal exam is automatically loaded in the image thumbnail area. Click the image thumbnail to preview the image.

Add images to the report in any of the following ways:

- Click to add the image to the report. The selected image displays “√”.

If you need to add different images in the report diagnosis area, select the images in the thumbnail area in turn.

- In the “Diagnostic Image” box, right-click and select [Add] to add the image in the thumbnail area to the box area. The thumbnail selection box of the added image is displayed as “√”.

Right-click the image in the Diagnostic image box in the report, and the menu pops up with “Left”, “Right” and “Delete”:

- Select [Left] or [Right] to adjust the image order.
- Select [Delete] to delete the added images from the report.

## 8.2.3 Adding Diagnosis Description

### To add from the library

Perform the following procedure:

1. Click  to expand the knowledge base in the library area of the report management screen.
2. Expand the nodes at all levels and double-click to add the image presentation and impression to the report body directly.

Double-click other nodes in the knowledge base. Add a new node to the text area of the report.

To replace the content of the report body with the content of the knowledge base, right-click the knowledge base screen and select [Replace to Report] to replace the content of the report body with the content of the knowledge base.

### To add from the report body

Perform the following procedure:

1. Click the “Image presentation” or “Impression” area in the body of the report to locate the cursor.
2. Use the keyboard to edit and enter the description of the condition.

Right-click the mouse and a context menu pops up. Common context menus and shortcuts such as [Select All] and [Copy] are supported.

## 8.2.4 Setting Positive/Negative

In the lower part of the text area, you can directly define the case as positive or negative. The default value is “Unknown”. By clicking the drop-down arrow button and selecting the corresponding value, the value will be saved when the report is saved.

## 8.3 Save a Report

When the report is finished and the current content needs to be saved, click [Save] in the operation area to save the current report text and the positive/negative status. The [Save] button turns gray.

The [Save] button is activated when the report is edited or the positive/negative result is switched.

## 8.4 Preview a Report

Click [Preview] in the operating area to display the review screen of the generated report. The default display ratio is 75%. You can switch to 100% for display. Click [Print] to print the currently previewed report.

## 8.5 Print a Report

Select [Print] to print the report, or select [Preview] > [Print] to preview the report.

A confirmation dialog box of printing report pops up. Select [Yes] to print the report to the connected printer.

After the report is printed,  is marked on the upper-right corner of the report.

## 8.6 Deleting a Report

Perform the following procedure:



1. On the report management screen, click  (Report list button) to expand the history report list:

- “No reported” tab: check the list of unsaved reports.
- “Reported” tab: check the list of saved reports.

2. Search a report:

Select the query conditions and input the query keyword in the text box to fuzzy search for the animals meeting the conditions.

Click  to restore the default query conditions and view the animals that are examined on the current day.

3. In the queried report list, select the report to be deleted and click .
4. Click  (Report list button) to close the history report list.

## 8.7 Knowledge Base Management

---

### **TIP:**

Administrators can edit the public knowledge base template, while common users can only edit the template under the individual account.

---

Click  to expand the knowledge base in the library area of the report management screen.

The factory default value has a public knowledge base node. Users can add or modify the content of the knowledge base.

The template of the knowledge base is a tree structure, which can be divided into public template directory and personal template directory.

Select an item in the template, and the “Image Presentation” and “Impression” will be displayed in the content display area.

Double-click the template directory node to show or hide the directory.

You are allowed to import or export the knowledge base. For details, see the *Report Configuration* section in *Setup* chapter.

## 8.7.1 Adding a Knowledge Base

Perform the following procedure:

1. Right-click the main node and select “Add a knowledge base directory” from the context menu.
2. Add database directory node:
  - a. Select a node as required, and then right-click the node to display the shortcut menu.
  - b. Select “Add Knowledge Base Catalog” from the shortcut menu, and add a sub-knowledge base catalog node under this node.
  - c. Click the new knowledge base directory node, and then click [Modify] to edit the name in the Name text box.
3. Add knowledge base template:
  - a. Select a node and right-click to display the shortcut menu.
  - b. Select “Add Knowledge Base Template” from the shortcut menu.
  - c. Click [Modify] to edit in “Name”, “Image Presentation” and “Impression”.

## 8.7.2 Modifying Template

Perform the following procedure:

1. Double-click the template directory node to expand the knowledge base entry.
2. Choose a template node to edit, and then select [Edit].

The template name and content are editable, and the cursor is automatically located at the template name.

3. Edit contents in the corresponding text box.

After editing:

- Confirm: To overwrite the modified settings.
- Save as: Save the modified template as a knowledge base. The original template remains unchanged. Save the saved template in the same directory.
- Cancel: Cancel the modification.

## 8.7.3 Saving Report contents to Template

Perform the following procedure:

1. Double-click the template directory node to expand the knowledge base entry.



2. Click to select the knowledge base template in the knowledge base directory node.
3. In the report editing area, right-click in the “Image Presentation” or “Impression” area to display the shortcut menu.
4. Select “Save to Knowledge Base” to replace the “Image Presentation” and “Impression” in the selected knowledge base template.
5. Select [Confirm] to save the replacement.

### **8.7.4 Adjusting Contents**

Perform the following procedure:

1. Double-click the template directory node to expand the knowledge base entry.
2. Click to select the knowledge base template in the knowledge base directory node.
3. Select a node and right-click to display the shortcut menu.
  - Select “Move Up” or “Move Down” to adjust the order of the directory nodes or templates.
  - Select “Delete” to delete the directory node or template.

# 9 System Maintenance

---

---

## CAUTION

**Failure to perform periodic inspection and maintenance may cause the working conditions to deteriorate without the user's knowledge and thus result in equipment faults, damage, and even injury.**

---

A periodic maintenance and repair program must be established to ensure continuous safe performance of the system. It is the user's responsibility to check the equipment status and perform preventive inspection of the system.

There are two levels of maintenance. One level is maintenance by the user or operator, and the other level is maintenance by professional X-ray maintenance personnel.

## 9.1 Operator's Tasks

---

### WARNING

- **After the system starts, do not perform cleaning or maintenance of any component of the equipment. Be sure to shut down the system and disconnect the main power supply before cleaning or maintenance. Disconnect the cables between all the operated components and the system during cleaning, maintenance, and inspection.**
- **Ensure that no water or other liquids enter the system, to avoid electrical system short circuit or component corrosion.**
- **Because some substances of cleaning agents are harmful to the human body, the concentration of such substances in air cannot exceed the upper limit specified by relevant rules and regulations. Strictly observe the use instructions provided by the manufacturers of such cleaning agents.**
- **After cleaning and disinfection, fully ventilate the room and then power on the device. Residual flammable gases in the room may cause fire and explosion when the system is powered on?**
- **Do not use any other cleaning agents or solvents because they may darken the painting or smudge printed text.**
- **7. Do not directly clean the surface of the equipment with a cleaning spray, because the spray mist may seep into the equipment, damage electronic components, and form a combustible mixture of air and water vapors, posing a safety hazard.**

- **Do not remove any shelf cover. Do not remove or handle the internal components of the equipment. THESE ACTIONS COULD CAUSE SERIOUS BODILY INJURY AND/OR SYSTEM DAMAGE.**
- 

Perform the following procedure:

1. Power off the system and cut off the power supply to the equipment.
2. Check whether the cables between the main components of the system are connected properly.
3. Clean regularly.

You are advised to clean the device and all contaminated parts twice per day, and the duration of cleaning the same part each time does not exceed 3 minutes, especially for the parts in contact with animals, including the flat panel detector, detector tray of the radiography stand, and handrail. Soak a soft cloth in ethanol (75%) or isopropanol (70%) solution. Then use it to clean the enclosure and surface of the device. After cleaning, use a soft cotton cloth to dry the display immediately, and wipe off the contrast agent stains (if any) as soon as possible.

## 9.2 Service Tasks

---

### **NOTE:**

- It is suggested to contact the Customer Service Department or sales representative to recalibrate the X-ray tube after the tube has been used for one year.
  - It is suggested to contact the Customer Service Department or sales representative to recalibrate the high voltage generator when it has not been used for more than two weeks.
  - It is suggested to contact the Customer Service Department or sales representative to recalibrate the ionization chamber when it has not been used for more than two months.
  - Perform FPD calibration and maintenance periodically to keep the performance at a constant level. Refer to the *Setup* chapter of this manual for operation instructions of detector calibration.
- 

Only service engineers trained on medical X-ray equipment can perform maintenance and repair of this system. The equipment manufacturer recommends that initial system maintenance be performed after one month and before the third month following system installation and operation. In normal cases, maintenance should be performed every 12 months based on the system operation status.

If many animals are examined every day (for example, 125 animals per day) after system installation, the maintenance cycle should be shortened. For example, perform full maintenance every 6 months.

# 10 System Specifications

## 10.1 Technical Specifications

Item	Value	
Power supply	Voltage	AC single-phase power, 100-240VAC, $\pm 10\%$
	Frequency	50/60Hz $\pm 1$ Hz
	Input current valid value	220VAC $\pm 10\%$ , $\geq 13$ A RMS 110VAC $\pm 10\%$ , $\geq 18$ A RMS
Mechanical Parameters	Column height	$\leq 2000$ mm
	SID	$\geq 1050$ mm
	Size of table top	1200mm $\times$ 650mm, tolerance $\pm 20$ mm
	Height of table top	770mm, tolerance $\pm 20$ mm
	Movement of table top	Four-way floating
		Stroke: Horizontal $\geq \pm 100$ mm, vertical $\geq \pm 50$ mm
Load	$\geq 80$ kg	
Electric power	Output power	32 kW
	Nominal electric power	32 kW (320mA, 100kV, 0.1s)
	Maximum output power	32 kW (320mA, 100kV)
Load factor regulating range	X-ray tube voltage/kV	40 kV - 125 kV, the minimum step is 1 kV, and the deviation is $\leq \pm 10\%$
	X-ray tube current/mA	10 mA - 500 mA, deviation $\leq \pm 20\%$
	Loading time/ms	1 ms - 8000 ms, deviation $\leq \pm (10\% + 1\text{ms})$
	Current time product/mAs	0.1 mAs - 125 mAs, deviation $\leq \pm (10\% + 0.2\text{mAs})$
	Exposure technique	kV-mA-ms
kV-mAs		

Item		Value
Flat panel detector	Material	CsI
	Detection unit array material	a-Si
	Detector size	43 cm×43 cm, deviation ≤ 5%
	Image matrix	3072×3072 pixels
	X-ray sensitive array	140 um
	DQE	Under the dose condition of RQA5 and 10 μGy and when the spatial frequencies are 0 lp/mm, 0.5 lp/mm, 1.0 lp/mm, 1.5 lp/mm, 2.0 lp/mm, 2.5 lp/mm, 3.0 lp/mm and 3.5 lp/mm, the DQE typical values are 0.7, 0.53, 0.43, 0.36, 0.32, 0.27, 0.21, and 0.14 respectively. The deviation does not exceed -0.06 and there is no upper limit.
Image acquisition workstation monitor	Screen size	≥21 inches
	Type	Colored, LCD
	Screen pitch	≤0.294 mm
	Resolution	1920×1080
	Maximum brightness	≥250 cd/m <sup>2</sup>
Image acquisition workstation host computer	CPU	Intel Core 2.0 GHz or above
	Memory	≥4 GB
	Hard disk	≥250 GB
	Operating system	Windows 10 Enterprise LTSC, 64 bit
	Image processing system	Operator console control software
Imaging Performance	Image size	≥ 430 mm×430 mm
	Image matrix	≥ 3072×3072 pixels
	Spatial resolution	≥ 3.6 lp/mm
Operating conditions	Relative humidity	20% - 75%
	Atmospheric pressure	62 kPa - 106 kPa
	Ambient temperature	10°C - 38°C
Storage and transportation conditions	Relative humidity	20% - 90%
	Atmospheric pressure	62 kPa - 106 kPa
	Ambient temperature	-20 °C - 55°C
Physical specifications	Dimensions (W×D×H)	(1200±20)×(810±20)×(1895±20) mm
	Weight	235±10kg

## 10.2 Specifications of X-ray Assembly (E7239X)

### 10.2.1 General Data

IEC Classification: Class I, Type B

#### Electrical

- Circuit
  - High Voltage Generator: Constant potential high-voltage generator
  - Grounding: Center-grounded
- Nominal X-ray Tube Voltage  
Radiographic: 125 kV
- Nominal Focal Spot Value (IEC 60336 Edition 3)
  - Large Focus: 2.0
  - Small Focus: 1.0
- Nominal Anode Input Power (at 0.1s)

	50 Hz	60 Hz
Large Focus	42.5 kW	47 kW
Small Focus	21 kW	22.5 kW

- Motor Ratings  
Stator: XS-AV

	Starting		Running
Driven Frequency [Hz]	50/60		50/60
Input Power [W]	1050	270	43
Voltage [V]	200	100	40
<b>NOTE:</b> <ul style="list-style-type: none"> <li>• Applied voltage between common and main terminal.</li> <li>• The every applied voltage must be never exceeded 110% of the above specification.</li> </ul>			
Current [A]	6.0	3.0	1.2
<b>NOTE:</b> Common current.			
Min. Speed Up [s]	0.8	1.5	-
<b>NOTE:</b> The speed-up time is allowed up to 110% of the above specification.			
Capacitor [ $\mu$ F]	24	24	24

- Anode Speed

- 50 Hz: Minimum 2700 min<sup>-1</sup>
- 60 Hz: Minimum 3200 min<sup>-1</sup>
- Stator Resistance
  - Common-Main Winding: 27.5 Ω
  - Common-Auxiliary Winding: 58.0 Ω
- Resistance between Housing and Low Voltage Terminals: Minimum 2 MΩ
- Normal Operating Range of the Housing Temperature: 16°C- 75 °C
- Mode of Operation: Intermittent

## Mechanical

- Dimensions
  - see “10.2.6 Dimensional Outline”.
  - Overall Length: 479 mm
  - Maximum Diameter: 152.4 mm
- Target
  - Anode Angle: 16 degrees
  - Diameter: 74 mm
  - Construction: Rhenium-Tungsten faced Molybdenum
- Filtration
  - Permanent Filtration: 0.9 mm Al / 75 kV IEC 60522:1999
  - The additional filtration thickness allowed to be added is 0.4 mm to 1.5 mm: max. 2.4 mm Al / 75 kV
- Radiation Protection (In Accordance with IEC 60601-1-3)  
Leakage Technique Factor: 125 kV, 4 mA
- X-ray Coverage: 354 × 354 mm at SID 750 mm
- Weight (Approx.): 16 kg
- High Voltage Receptacle: To meet requirement of IEC 60526
- Cooling Method: Natural or forced air
- Housing Model No: XH-121

### 10.2.2 Maximum and Minimum Ratings

At any time, these values must not be exceeded.

- Maximum X-ray Tube Voltage
  - Radiographic: 125 kV
  - Between Anode (or Cathode) and Ground: 62.5 kV
  - Minimum X-ray Tube Voltage: 40 kV
- Maximum X-ray Tube Current
  - Large Focus: 570 mA
  - Small Focus: 340 mA
- Maximum Filament Current
  - Large Focus: 5.1 A
  - Small Focus: 5.1 A

- Filament Voltage
  - Large Focus (At max. filament current 5.1A): 7.7 V - 10.4 V
  - Small Focus (At max. filament current 5.2A): 5.8 V - 7.8 V
  - Filament Frequency Limit: 0 -25 kHz
- Thermal Characteristics
  - Anode Heat Content: 100 kJ (140 kHU)
  - Maximum Anode Heat Dissipation: 475 W (667 HU/s)
  - X-ray Tube Assembly Heat Content: 900 kJ (1250 kHU)
- Nominal Continuous Input Power  
Without Air-circulator: 180 W (15 kHU/min)



### 10.2.3 Maximum Rating Charts (Absolute Maximum Rating Charts)

Conditions: Tube Voltage  
Constant potential high-voltage generator  
Stator Power Frequency 60Hz

Nominal Focal Spot Value: 2.0 ■

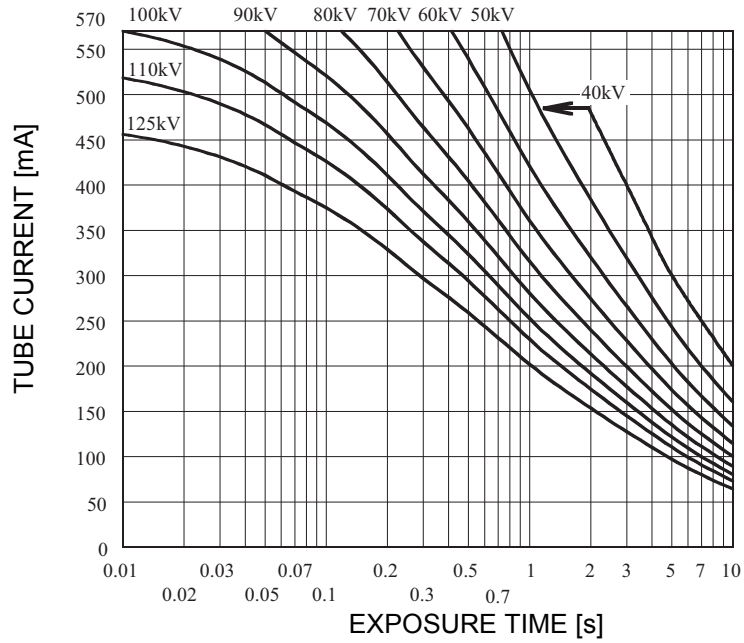

Nominal Focal Spot Value: 1.0 □

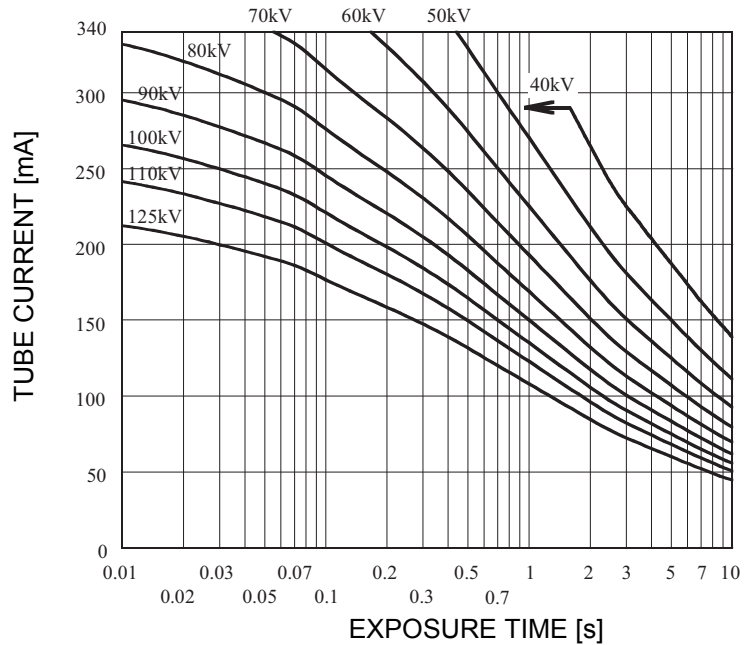

Conditions: Tube Voltage  
Constant potential high-voltage generator  
Stator Power Frequency 50Hz

Nominal Focal Spot Value: 2.0 ■

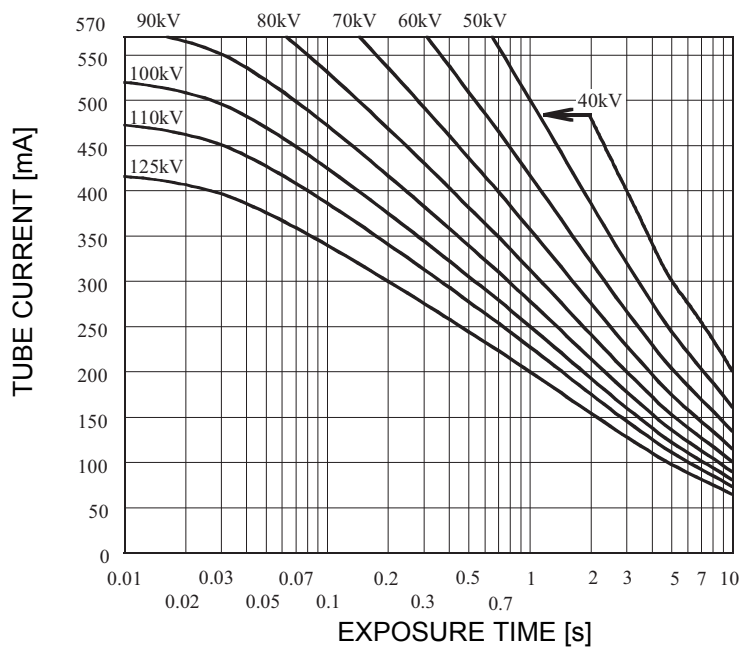

Nominal Focal Spot Value: 1.0 □

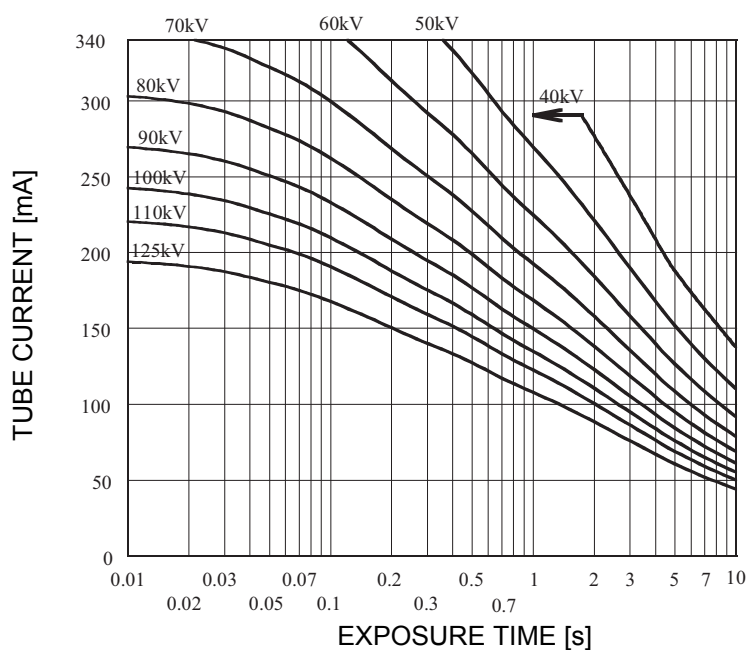

## 10.2.4 Emission and Filament Characteristics

Constant potential high-voltage generator

Nominal Focal Spot Value: 2.0 ■

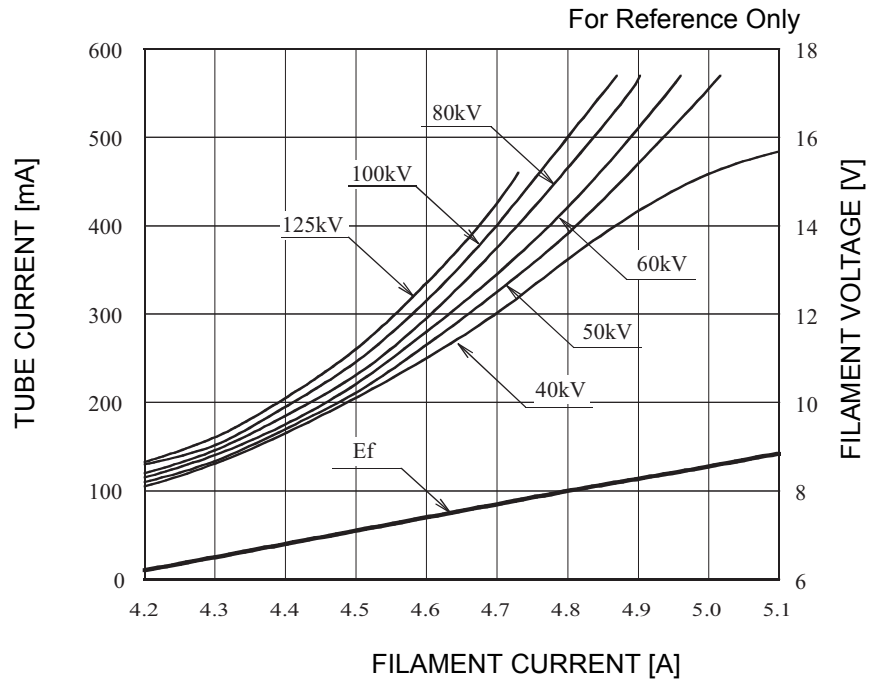

Nominal Focal Spot Value: 1.0 □

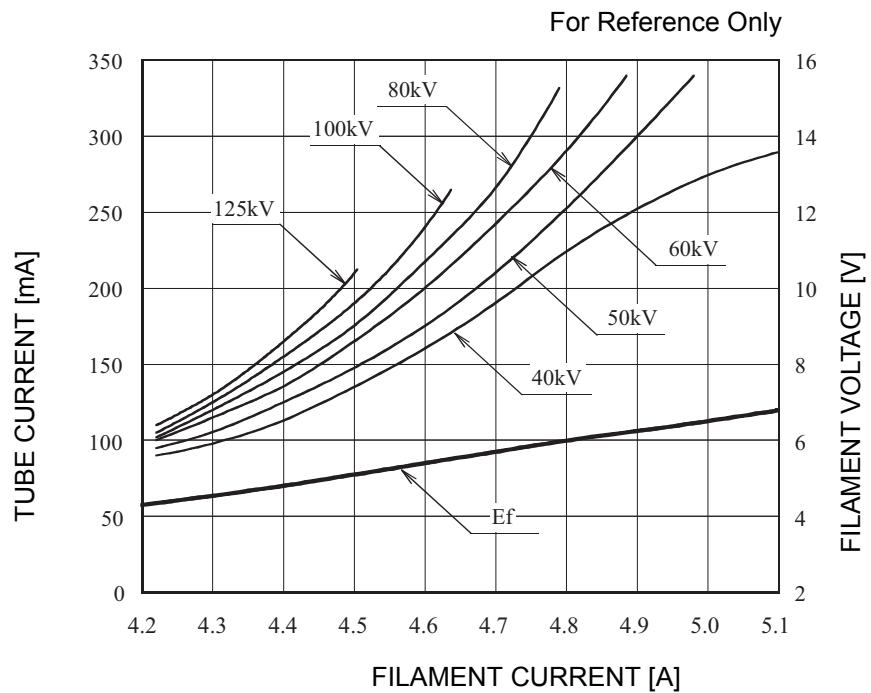

## 10.2.5 Thermal Characteristics

X-ray Tube Assembly Heating/Cooling Curve

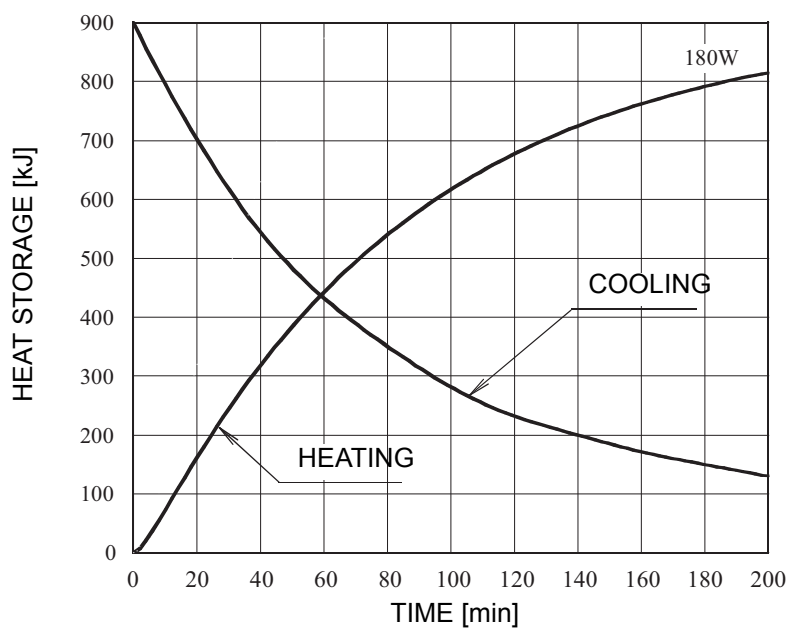

Anode Heating / Cooling Curve

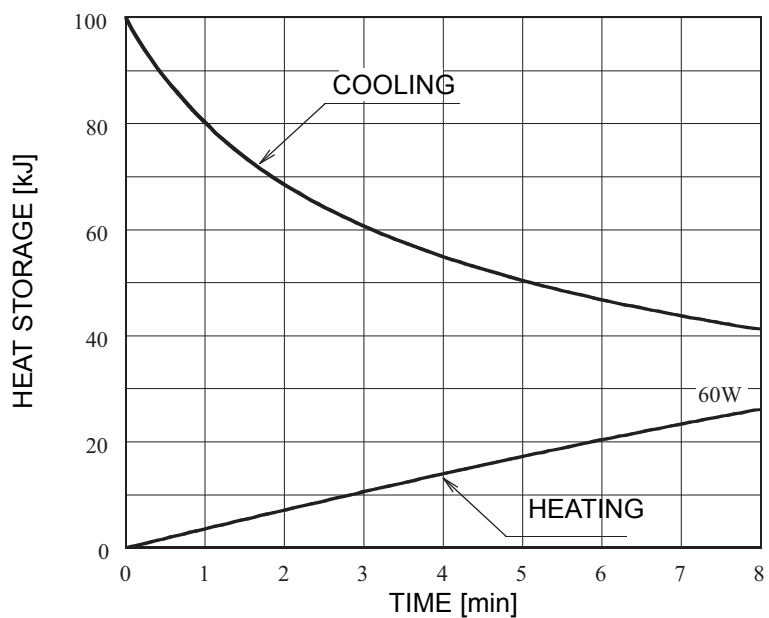

The heating curves are showing examples of average input power to the anode in operation.

### 10.2.6 Dimensional Outline

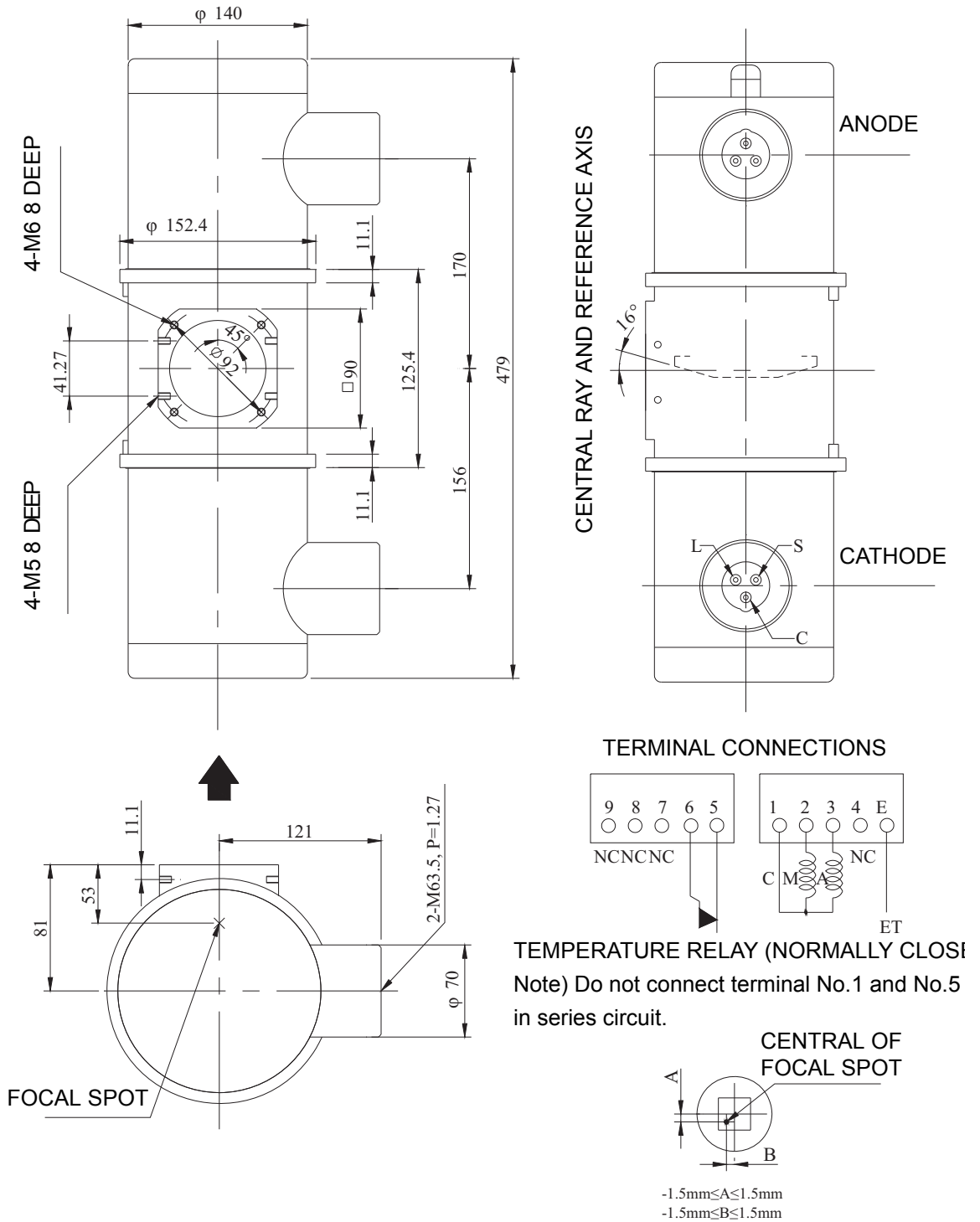

C: COMMON	A: AUX. WINDING OF THE STATOR	↑ : CENTRAL X-RAY
-----------	-------------------------------	-------------------

L: LARGE FOCUS	NC: NON CONNECTION	ANODE & CATHODE TERMINAL: IEC 60526 TYPE
S: SMALL FOCUS	ET: EARTH TERMINAL	M: MAIN WINDING OF THE STATOR

# 11 EMC Guidance and Manufacturer's Declaration

---

The system complies with the EMC standard IEC60601-1-2: 2014 as well as Safety restrictions on electromagnetic radiation exposure from CE.

Intended Environments: professional healthcare facility environment (except for near active HF SURGICAL EQUIPMENT and the RF shielded room of an ME SYSTEM for magnetic resonance imaging).

---

## **WARNING**

- The use of unapproved accessories may diminish system performance.
- Use of this equipment adjacent to or stacked with other equipment should be avoided because it could result in improper operation. If such use is necessary, this equipment and the other equipment should be observed to verify that they are operating normally.
- Use of accessories, transducers and cables other than those specified or provided by the manufacturer of this equipment could result in increased electromagnetic emissions exposure beyond intended use or decreased electromagnetic immunity of this equipment and result in improper operation.
- Portable RF communications equipment (including peripherals such as antenna cables and external antennas) should be used no closer than 30 cm (12 inches) to any part of the system, including cables specified by the manufacturer. Otherwise, degradation of the performance of this equipment could result.
- This equipment has been tested for radiated RF immunity only at selected frequencies, and use nearby of emitters at other frequencies could result in improper operation

---

## **NOTE:**

- The EMISSIONS characteristics of this equipment make it suitable for use in industrial areas and hospitals (CISPR 11 class A). If it is used in a residential environment (for which CISPR 11 class B is normally required) this equipment might not offer adequate protection to radio-frequency

communication services. The user might need to take mitigation measures, such as relocating or re-orienting the equipment.

- Recommendations for actions that are known to affect the EMISSIONS and IMMUNITY of equipment throughout the EXPECTED SERVICE LIFE:
    - o recommendations for maintenance or service intervals;
    - o service procedures to maintain effectiveness of shields and grounds;
    - o precautions to take if the use location is near (e.g. less than 1,5 km from) AM, FM or TV broadcast antennas.
  - The system needs special precautions regarding EMC and needs to be installed and put into service according to the EMC information provided below.
  - Operation of system, in the case that the animal physiological signal is lower than the minimum amplitude or value specified in the product specifications, may cause inaccurate results.
  - Portable and mobile RF communications equipment can affects system.
- See Table 11-1, Table 11-2, Table 11-3 and Table 11-4 below.

**Table 11-1**

<b>GUIDANCE AND MINDRAY ANIMAL MEDICAL DECLARATION-ELECTROMAGNETIC EMISSIONS</b>		
The system is intended for use in the electromagnetic environment specified below. The customer or the user of system should assure that it is used in such an environment.		
<b>EMISSIONS TEST</b>	<b>COMPLIANCE</b>	<b>ELECTROMAGNETIC ENVIROMENT - GUIDANCE</b>
RF emissions CISPR 11	Group 1	The system uses RF energy only for its internal function. Therefore, its RF emissions are very low and are not likely to cause any interference in nearby electronic equipment.
RF emissions CISPR 11	Class A	The system is suitable for use in all establishments other than domestic and those directly connected to the public low-voltage power supply network that supplies buildings used for domestic purposes.
Harmonic Emissions IEC 61000-3-2	Not applicable	
Voltage Fluctuations/ Flicker Emissions IEC 61000-3-3	Not applicable	



**Table 11-2**

<b>GUIDANCE AND MINDRAY ANIMAL MEDICAL DECLARATION-ELECTROMAGNETIC IMMUNITY</b>			
The system is intended for use in the electromagnetic environment specified below. The customer or the user of system should assure that it is used in such an environment.			
<b>IMMUNITY TEST</b>	<b>IEC 60601 TEST LEVEL</b>	<b>COMPLIANCE LEVEL</b>	<b>ELECTROMAGNETIC ENVIRONMENT-GUIDANCE</b>
Electrostatic Discharge(ESD) IEC 61000-4-2	±8 kV contact; ±15 kV air	±8 kV contact; ±15 kV air	Floors should be wood, concrete or ceramic tile. If floors are covered with synthetic material, the relative humidity should be at least 30%.
Electrical fast Transient / burst IEC 61000-4-4	±2 kV for power supply lines; ±1 kV for input/output lines	±2 kV for power supply lines; ±1 kV for input/output lines	Mains power quality should be that of a typical commercial or hospital environment.
Surge IEC 61000-4-5	±1 kV line(s) to line(s); ±2 kV line(s) to earth	±1 kV line(s) to line(s); ±2 kV line(s) to earth	Mains power quality should be that of a typical commercial or hospital environment.
Voltage dips, Short interruptions and voltage variation on power supply input voltage IEC 61000-4-11	0% U <sub>T</sub> ; 0,5 cycle At 0°, 45°, 90°, 135°, 180°, 225°, 270° and 315°  0% U <sub>T</sub> ; 1 cycle 70% U <sub>T</sub> for 25/30 cycle at 0°  0% U <sub>T</sub> ; 250/300 cycle	0% U <sub>T</sub> ; 0,5 cycle At 0°, 45°, 90°, 135°, 180°, 225°, 270° and 315°  0% U <sub>T</sub> ; 1 cycle 70% U <sub>T</sub> for 25/30 cycle at 0°  0% U <sub>T</sub> ; 250/300 cycle	Mains power quality should be that of a typical commercial or hospital environment. If you require continued operation during power mains interruptions, it is recommended that our product be powered from an uninterruptible power supply or a battery.
Power frequency (50/60 Hz) magnetic field IEC 61000-4-8	30 A/m	30 A/m	Power frequency magnetic fields should be at levels characteristic of a typical location in a typical commercial or hospital environment.

**NOTE:**

U<sub>T</sub> is the A.C. mains voltage prior to application of the test level.

**Table 11-3**

<b>GUIDANCE AND MINDRAY ANIMAL MEDICAL DECLARATION-ELECTROMAGNETIC IMMUNITY</b>			
The system is intended for use in the electromagnetic environment specified below. The customer or the user of system should assure that it is used in such an environment.			
<b>IMMUNITY TEST</b>	<b>IEC 60601 TEST LEVEL</b>	<b>COMPLIANCE LEVEL</b>	<b>ELECTROMAGNETIC ENVIRONMENT-GUIDANCE</b>
Conducted RF IEC 61000-4-6	3 Vrms 0,15 MHz – 80 MHz	3 Vrms 0,15 MHz – 80 MHz	Portable and mobile RF communications equipment should be used no closer to any part of system, including cables, than the recommended separation distance calculated from the equation applicable to the frequency of the transmitter. Recommended separation distance $d = 1.2 \times \sqrt{P}$
	6 Vrms in ISM and amateur radio bands between 0,15 MHz and 80 MHz	6 Vrms in ISM and amateur radio bands between 0,15 MHz and 80 MHz	
Radiated RF IEC 61000-4-3	10 V/m 80MHz - 2.7GHz	10 V/m 80MHz - 2.7GHz	$d = 1.2 \times \sqrt{P}$ 80 MHz to 800 MHz $d = 2.3 \times \sqrt{P}$ 800 MHz to 2.7GHz
Proximity fields from RF wireless communications equipment IEC 61000-4-3	27 V/m 380–390 MHz	27 V/m	Where, P is the maximum output power rating of the transmitter in watts (W) according to the transmitter manufacturer and d is the recommended separation distance in meters (m).  Field strengths from fixed RF transmitters, as determined by an electromagnetic site survey, should be less than the compliance level in each frequency range.  Interference may occur in the vicinity of equipment marked with the following symbol:  
	28 V/m 430–470 MHz, 800–960 MHz, 1700–1990 MHz, 2400–2570 MHz	28 V/m	
	9 V/m 704–787 MHz, 5100–5800 MHz	9 V/m	

**Table 11-3**

<b>GUIDANCE AND MINDRAY ANIMAL MEDICAL DECLARATION-ELECTROMAGNETIC IMMUNITY</b>			
The system is intended for use in the electromagnetic environment specified below. The customer or the user of system should assure that it is used in such an environment.			
<b>IMMUNITY TEST</b>	<b>IEC 60601 TEST LEVEL</b>	<b>COMPLIANCE LEVEL</b>	<b>ELECTROMAGNETIC ENVIRONMENT-GUIDANCE</b>

Note 1: At 80 MHz and 800 MHz, the higher frequency range applies.

Note 2: These guidelines may not apply in all situations. Electromagnetic propagation is affected by absorption and reflection from structures, objects and people.

a. Field strengths from fixed transmitters, such as base stations for radio (cellular /cordless) telephones and land mobile radios, amateur radio, AM and FM radio broadcast and TV broadcast cannot be predicted theoretically with accuracy. To assess the electromagnetic environment due to fixed RF transmitters, an electromagnetic site survey should be considered. If the measured field strength in the location in which system is used exceeds the applicable RF compliance level above, system should be observed to verify normal operation. If abnormal performance is observed, additional measures may be necessary, such as reorienting or relocating the system.

b. Over the frequency range 150 kHz to 80 MHz, field strengths should be less than 3 V/m.

**Table 11-4**

<b>RECOMMENDED SEPARATION DISTANCES BETWEEN PORTABLE AND MOBILE RF COMMUNICATION DEVICE AND THE SYSTEM</b>			
The system is intended for use in an electromagnetic environment in which radiated RF disturbance are controlled. The customer or the user of system can help prevent electromagnetic interference by maintaining a minimum distance between portable and mobile RF communication equipment (transmitters) and system as recommended below, according to the maximum output power of the communication equipment.			
<b>Rated Maximum Output power of Transmitter (W)</b>	<b>Separation Distance According to Frequency of Transmitter (m)</b>		
	<b>150kHz -80MHz <math>d = 1.2 \sqrt{P}</math></b>	<b>80MHz-800MHz <math>d = 1.2 \sqrt{P}</math></b>	<b>800MHz-2.7GHz <math>d = 2.3 \sqrt{P}</math></b>
0.01	0.12	0.12	0.23
0.1	0.38	0.38	0.73
1	1.2	1.2	2.3
10	3.8	3.8	7.3
100	12	12	23

For transmitters at a maximum output power not listed above, the recommended separation distanced in meters (m) can be determined using the equation applicable to the frequency of the transmitter, where P is the maximum output power rating of the transmitter in watts (W) according to the transmitter manufacturer.

If system image distortion occurs, it may be necessary to position system further from sources of conducted RF noise or to install external power source filter to minimize RF noise to an acceptable level.

Note 1: At 80 MHz and 800 MHz, the separation distance for the higher frequency range applies.

Note 2: These guidelines may not apply in all situations. Electromagnetic propagation is affected by absorption and reflection from structures, objects and people.

**Table 11-5 Cable sample**

No.	Name	Cable length (m)	Shield or not	Remarks
1.	Power input cable of the whole unit(Including earthing wire)	5	No	/
2.	Serial interface cable between the high voltage generator and the hand switch	1.5	Yes	/
3.	Collimator power cord	2.8	Yes	/
4.	Operation signal patch cord in the high voltage generator	2.7	Yes	/
5.	Anode drive cable	4.3	Yes	/
6.	Flat panel power cord	2.4	No	/
7.	DB9 extension cable	5	Yes	/
8.	Exposure indicator cable	3	Yes	/
9.	USB2.0 extension cable	5	Yes	/
10.	Footswitch patch cord	3	Yes	/
11.	HDMI 1.3a cable of 23.8-inch display	5	Yes	/
12.	AC-DC module power cord	1.5	No	/